

Van Gorp

CEMA B4 & C5 CLASS IDLERS

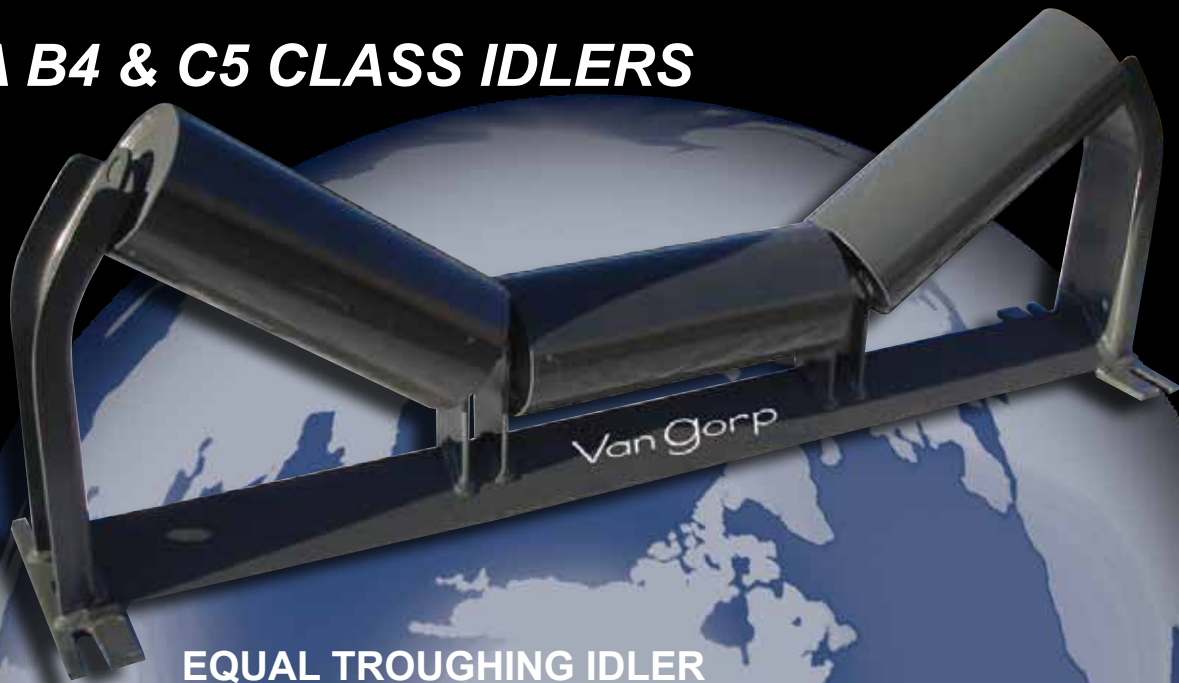

EQUAL TROUGHING IDLER



RETURN IDLER



TROUGHED IMPACT IDLER

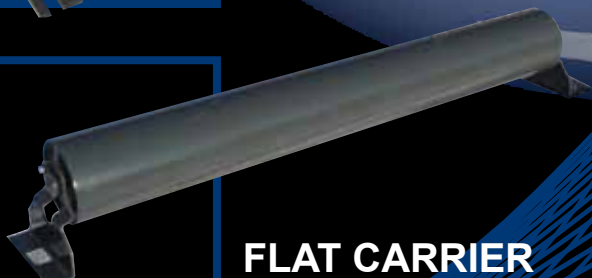

FLAT CARRIER

GOODYEAR
GOODYEARBELTING.COM

Call Toll Free: 1-866-711-4673
International: +1-727-342-5086

**We Ship
World Wide**

Very low roll-drag with 25% energy savings.

BEARING & SEAL ARRANGEMENT

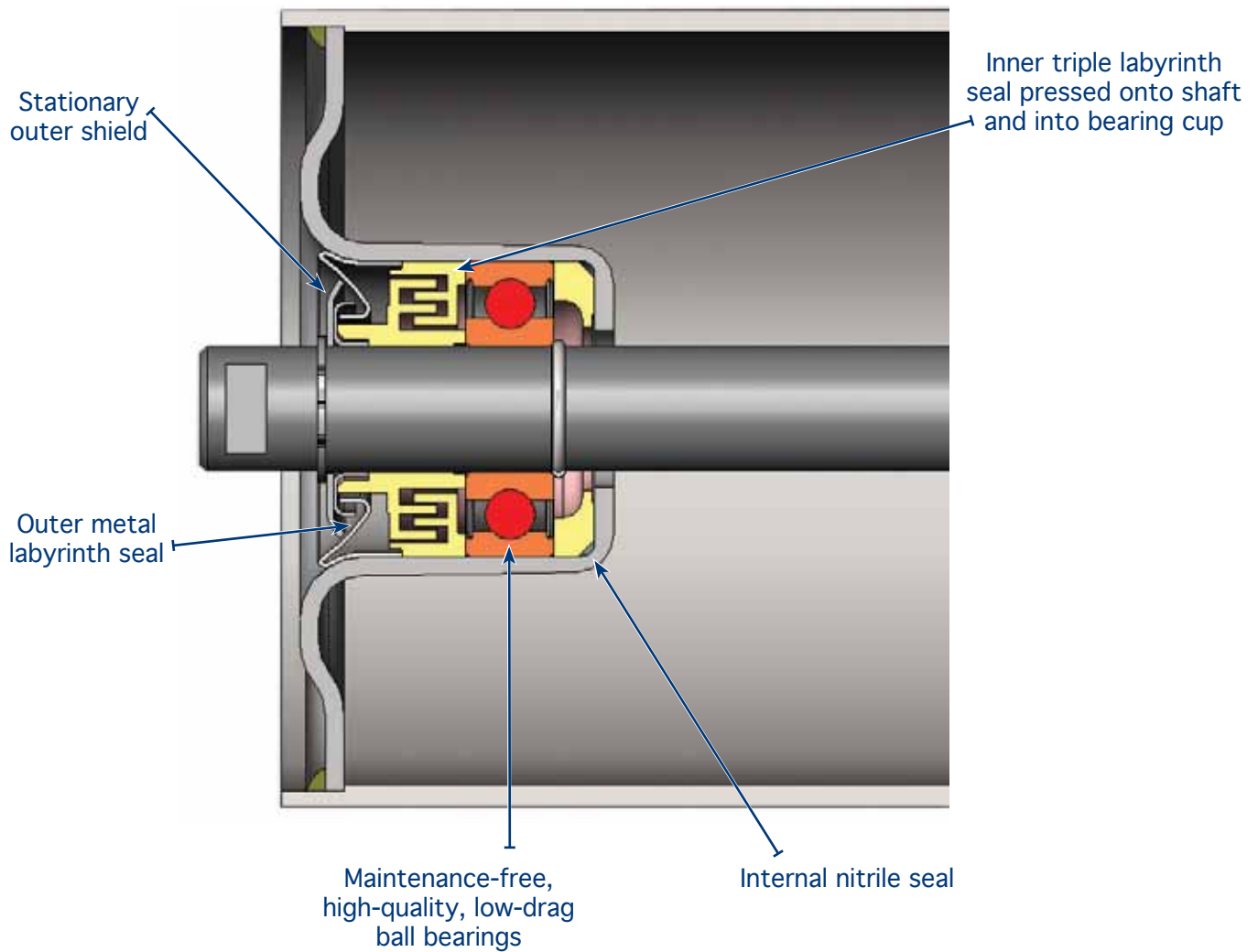

Van Gorp Idlers conform to CEMA standards for dimensions and meet or exceed CEMA load ratings.

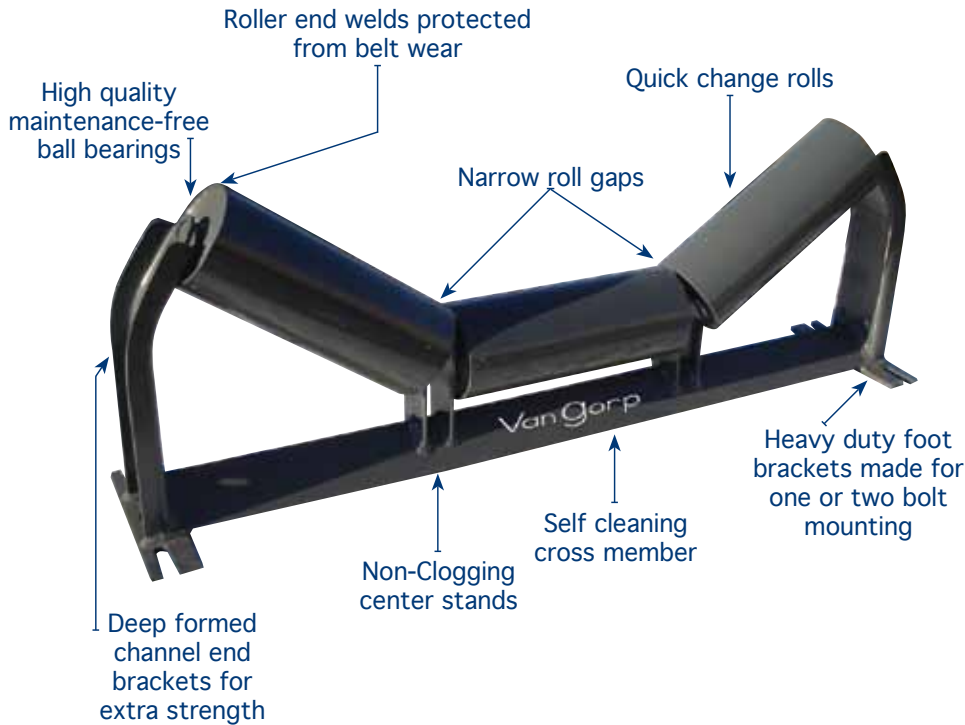

EQUAL TROUGHING IDLER

Troughed belt idlers are available in roll inclinations of 20, 35 and 45 degrees.



RETURN IDLER

Carries empty belt on the return run.



TROUGHED IMPACT IDLER

Troughed belt rubber cushion idlers protect the belt by absorbing impacts at loading and transfer points. They are available in inclinations of 20, 35 and 45 degrees.

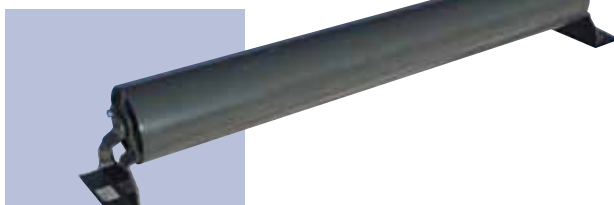

FLAT CARRIER

Used for picking and sorting conveyors.

Also available in heavy duty live shaft design

GOODYEAR
GOODYEARBELTING.COM

Call Toll Free: 1-866-711-4673
International: +1-727-342-5086

We Ship
World Wide

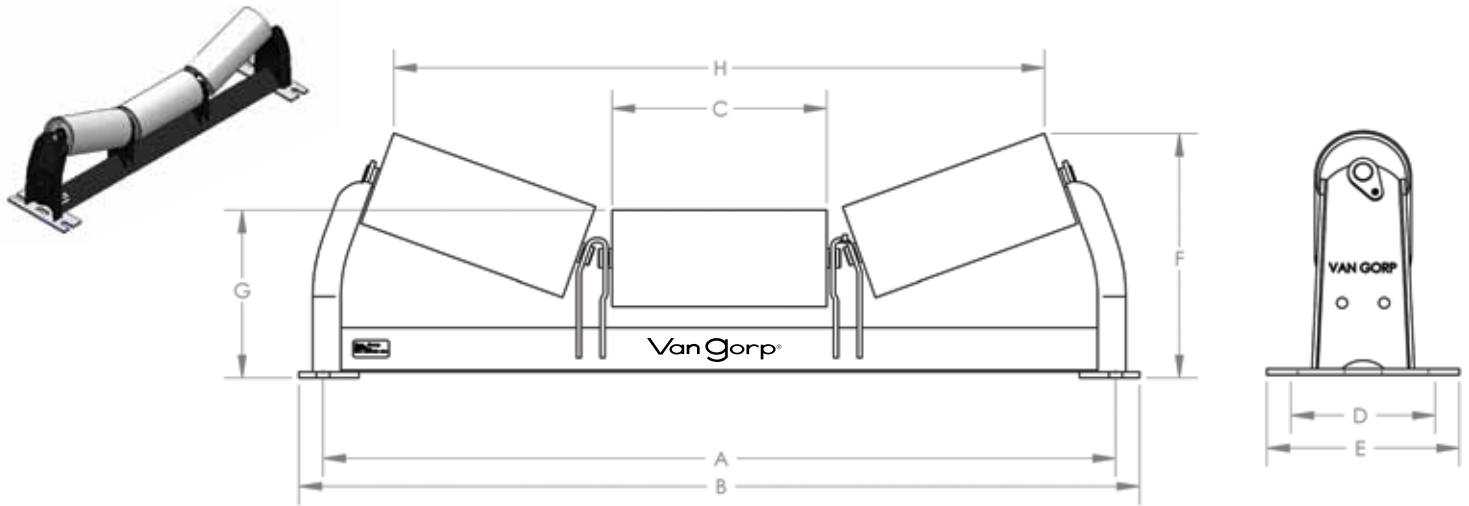

B4 Equal Troughing Idlers

Assembly Description	Belt Width	A	B	C	D	E	F	G	H	Assembly Weight
B4-20TE-18	18	27	29	6.75	5.5	8	9.42	7	20.69	31
B4-20TE-24	24	33	35	8.94	5.5	8	10.14	7	27.04	38
B4-20TE-30	30	39	41	11.13	5.5	8	10.88	7	33.33	42
B4-20TE-36	36	45	47	13.25	5.5	8	11.61	7	39.45	48
B4-35TE-18	18	27	29	6.75	5.5	8	11.11	7	18.94	35
B4-35TE-24	24	33	35	8.94	5.5	8	12.31	7	24.69	39
B4-35TE-30	30	39	41	11.13	5.5	8	13.56	7	30.50	45
B4-35TE-36	36	45	47	13.25	5.5	8	14.78	7	36.13	50

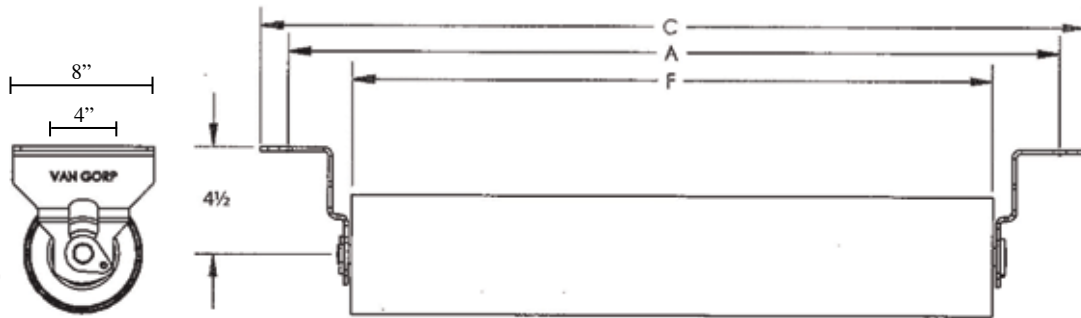

B4 Return Idlers

Assembly Description	Belt Width	A	C	F	Assembly Weight
B4-4R-18	18	27	29	21.38	15
B4-4R-24	24	33	35	27.38	18
B4-4R-30	30	39	41	33.38	20
B4-4R-36	36	45	47	39.38	23

Also available with 1.5" drop:

B4-1R-18	18	27	29	21.38	14
B4-1R-24	24	33	35	27.38	16
B4-1R-30	30	39	41	33.38	19
B4-1R-36	36	45	47	39.38	22

End Stands for Flat Carrier Idlers

Standard End Stand

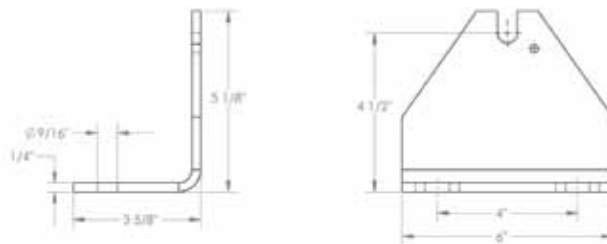

Optional End Stand



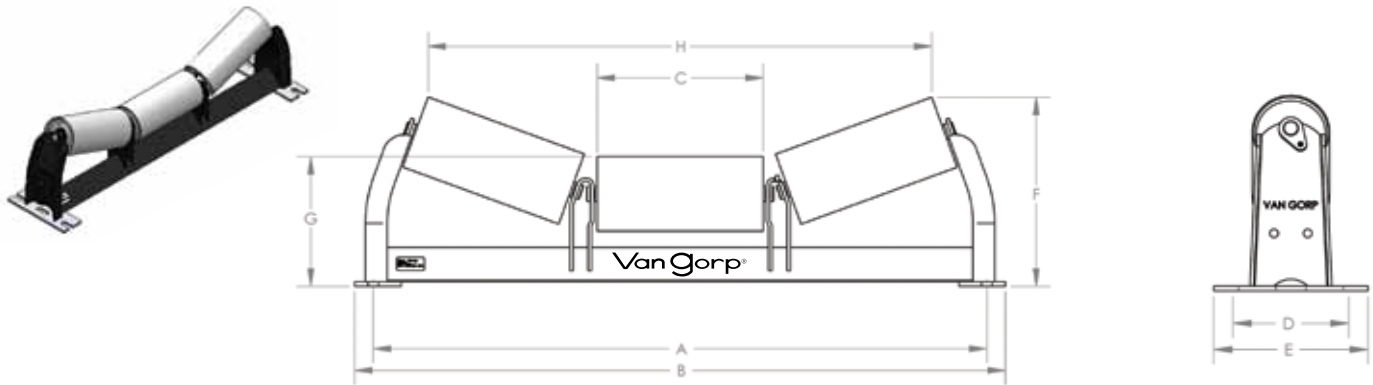

C5 Equal Troughing Idlers

Assembly Description	Belt Width	A	B	C	D	E	F	G	H	Assembly Weight
C5-20TE-24	24	33	35	8.94	5.5	8	11.69	8.50	27.06	52
C5-20TE-30	30	39	41.5	11.13	5.5	9.5	12.56	8.63	13.38	59
C5-20TE-36	36	45	47.5	13.25	5.5	9.5	13.31	8.63	39.44	67
C5-20TE-42	42	51	53.5	15.44	5.5	9.5	14.44	9	45.75	75
C5-20TE-48	48	57	59.5	17.63	5.5	9.5	15.19	9	52.06	83
C5-35TE-24	24	33	35	8.94	5.5	8	13.81	8.50	24.56	53
C5-35TE-30	30	39	41.5	11.13	5.5	9.5	15.19	8.63	30.38	61
C5-35TE-36	36	45	47.5	13.25	5.5	9.5	16.38	8.63	35.94	69
C5-35TE-42	42	51	53.5	15.44	5.5	9.5	18.06	9	41.75	78
C5-35TE-48	48	57	59.5	17.63	5.5	9.5	19.31	9	47.50	86

C5 Impact Troughing Idlers

Assembly Description	Belt Width	A	B	C	D	E	F	G	H	Assembly Weight
C5-20TEI-36	36	45	47.5	13.25	5.5	9.5	13.06	8.63	39.49	75
C5-20TEI-42	42	51	53.5	15.44	5.5	9.5	14.19	9	45.54	85
C5-20TEI-48	48	57	59.5	17.63	5.5	9.5	14.94	9	51.81	96
C5-35TEI-36	36	45	47.5	13.25	5.5	9.5	15.94	8.63	35.18	77
C5-35TEI-42	42	51	53.5	15.44	5.5	9.5	17.63	9	40.96	88
C5-35TEI-48	48	57	59.5	17.63	5.5	9.5	18.88	9	46.71	98

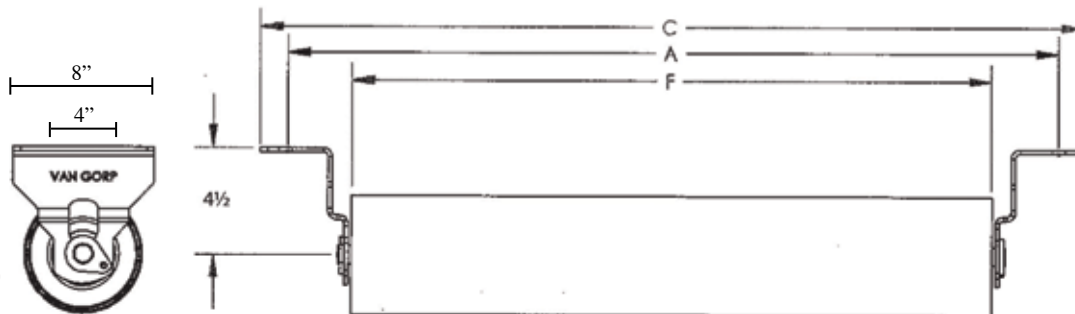

C5 Return Idlers

Assembly Description	Belt Width	A	C	F	Assembly Weight
C5-4R-24	24	33	35	27.38	26
C5-4R-30	30	39	41	33.38	30
C5-4R-36	36	45	47	39.38	35
C5-4R-42	42	51	53	45.38	39
C5-4R-48	48	57	59	51.38	43

Also available with 1.5" drop:

C5-1R-24	24	33	35	27.38	24
C5-1R-30	30	39	41	33.38	29
C5-1R-36	36	45	47	39.38	33
C5-1R-42	42	51	53	45.38	37
C5-1R-48	48	57	59	51.38	42

End Stands for Flat Carrier Idlers

Standard End Stand

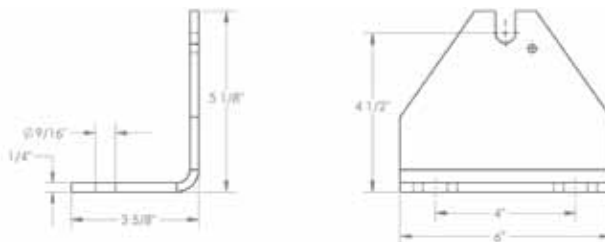

Optional End Stand



Van Gorp

1410 Washington St
PO Box 288
Pella, IA 50219
(641) 628-9212
www.vangorp.biz

MEMBER:



NSSGA



GOODYEAR
GOODYEARBELTING.COM

Call Toll Free: 1-866-711-4673
International: +1-727-342-5086

**We Ship
World Wide**

Van Gorp

CEMA D6 & E7 CLASS IDLERS



EQUAL TROUGHING IDLER



RETURN IDLER



TROUGHED IMPACT IDLER

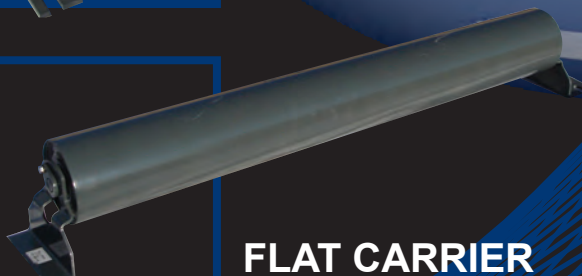

FLAT CARRIER

GOODYEAR
GOODYEARBELTING.COM

Call Toll Free: 1-866-711-4673
International: +1-727-342-5086

**We Ship
World Wide**

Very low roll-drag with 25% energy savings.

BEARING & SEAL ARRANGEMENT

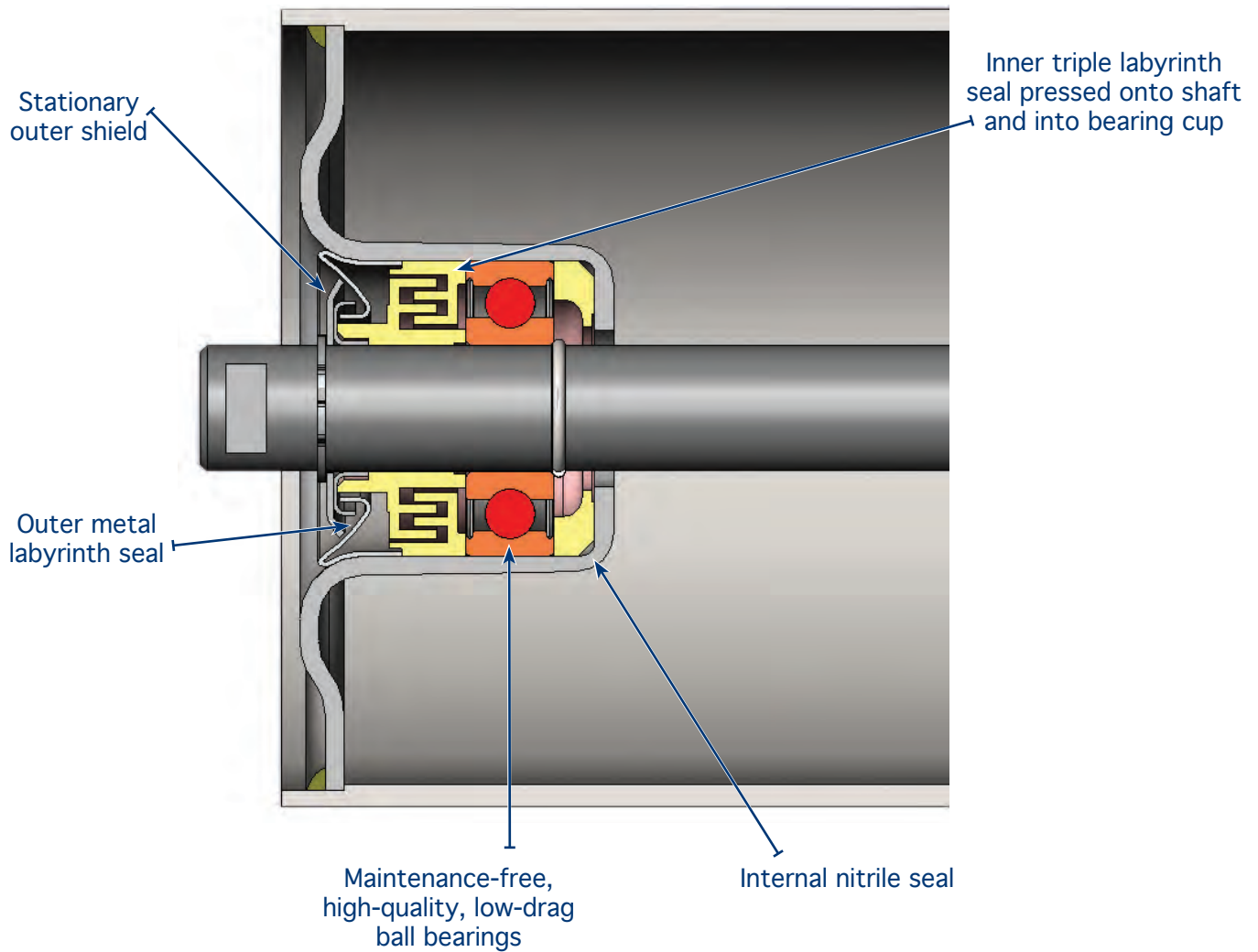

Van Gorp Idlers conform to CEMA standards for dimensions and meet or exceed CEMA load ratings.

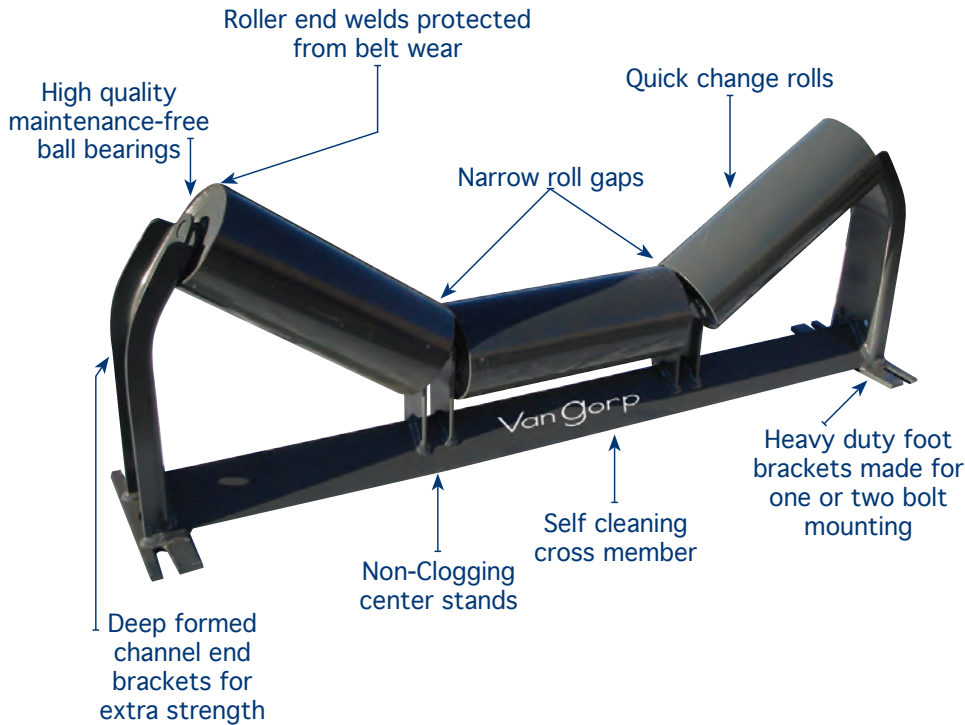

EQUAL TROUGHING IDLER

Troughed belt idlers are available in roll inclinations of 20, 35 and 45 degrees.



RETURN IDLER

Carries empty belt on the return run.



TROUGHED IMPACT IDLER

Troughed belt rubber cushion idlers protect the belt by absorbing impacts at loading and transfer points. They are available in inclinations of 20, 35 and 45 degrees.

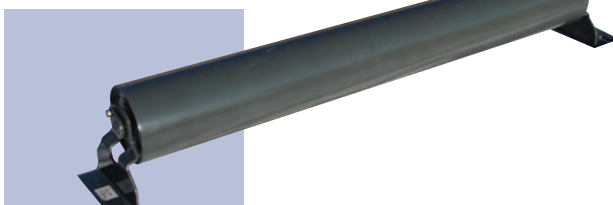

FLAT CARRIER

Used for picking and sorting conveyors.

Also available in heavy duty live shaft design

GOODYEAR
GOODYEARBELTING.COM

Call Toll Free: 1-866-711-4673
International: +1-727-342-5086

We Ship
World Wide

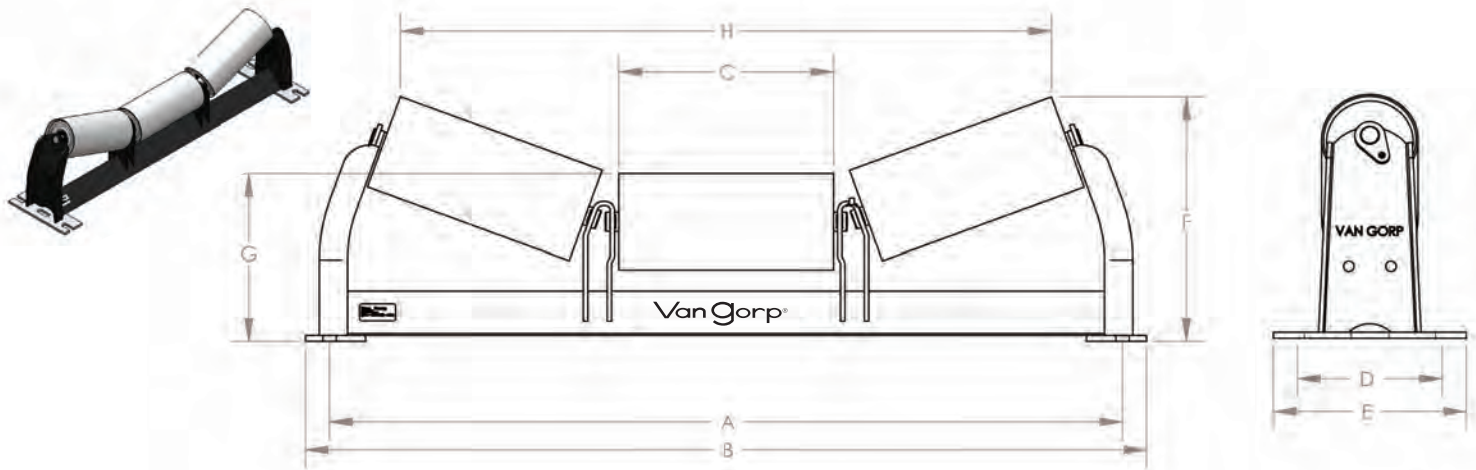

D6 Equal Troughing Idlers

Assembly Description	Belt Width	A	B	C	D	E	F	G	H	Assembly Weight
D6-20TE-36	36	45	47.5	13.25	5.5	9.50	13.75	9.13	39.13	75
D6-20TE-42	42	51	53.5	15.44	5.5	9.50	14.88	9.50	45.44	93
D6-20TE-48	48	57	59.5	17.63	5.5	9.50	15.63	9.50	51.75	103
D6-20TE-54	54	63	65.5	19.75	8.5	10.94	16.75	10	57.81	118
D6-20TE-60	60	69	71.5	21.75	8.5	10.94	17.38	10	63.56	128
D6-35TE-36	36	45	47.5	13.25	5.5	9.50	16.81	9.13	35.44	76
D6-35TE-42	42	51	53.5	15.44	5.5	9.50	18.44	9.50	41.19	96
D6-35TE-48	48	57	59.5	17.63	5.5	9.50	19.69	9.50	46.94	106
D6-35TE-54	54	63	65.5	19.75	8.5	10.94	21.31	10	52.56	125
D6-35TE-60	60	69	71.5	21.75	8.5	10.94	22.44	10	57.88	134

D6 Impact Troughing Idlers

Assembly Description	Belt Width	A	B	C	D	E	F	G	H	Assembly Weight
D6-20TEI-36	36	45	47.5	13.25	5.5	9.50	13.50	9.13	38.69	99
D6-20TEI-42	42	51	53.5	15.44	5.5	9.50	14.63	9.50	45	124
D6-20TEI-48	48	57	59.5	17.63	5.5	9.50	15.38	9.50	51.25	137
D6-20TEI-54	54	63	65.5	19.75	8.5	10.94	16.50	10	57.38	157
D6-20TEI-60	60	69	71.5	21.75	8.5	10.94	17.13	10	63.13	173
D6-35TEI-36	36	45	47.5	13.25	5.5	9.50	16.38	9.13	35	101
D6-35TEI-42	42	51	53.5	15.44	5.5	9.50	18	9.50	40.75	127
D6-35TEI-48	48	57	59.5	17.63	5.5	9.50	19.25	9.50	46.50	140
D6-35TEI-54	54	63	65.5	19.75	8.5	10.94	20.88	10	52.13	164
D6-35TEI-60	60	69	71.5	21.75	8.5	10.94	22	10	57.38	179

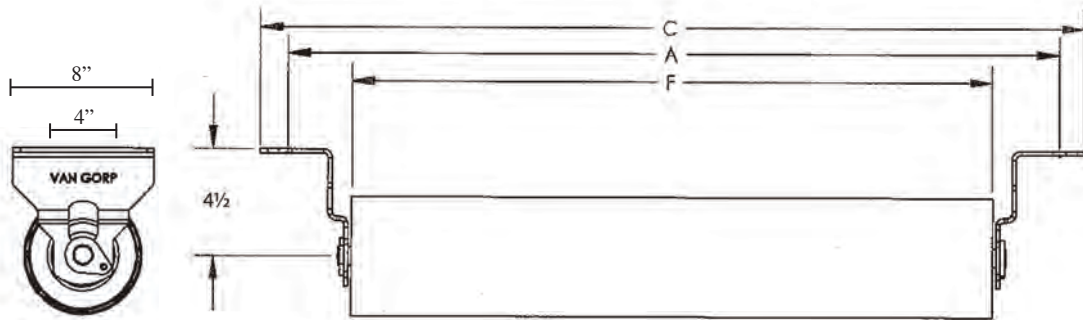

D6 Return Idlers

Assembly Description	Belt Width	A	C	F	Assembly Weight
D6-4R-36	36	45	47	39.38	46
D6-4R-42	42	51	53	45.38	52
D6-4R-48	48	57	59	51.38	58
D6-4R-54	54	63	65	57.38	64
D6-4R-60	60	69	71	63.38	70

Also available with 1.5" drop:

D6-1R-36	36	45	47	39.38	46
D6-1R-42	42	51	53	45.38	52
D6-1R-48	48	57	59	51.38	58
D6-1R-54	54	63	65	57.38	64
D6-1R-60	60	69	71	63.38	70

End Stands for Flat Carrier Idlers

Standard End Stand

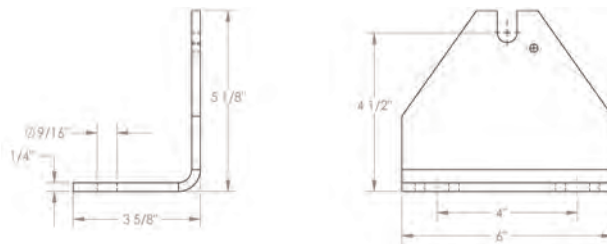

Optional End Stand



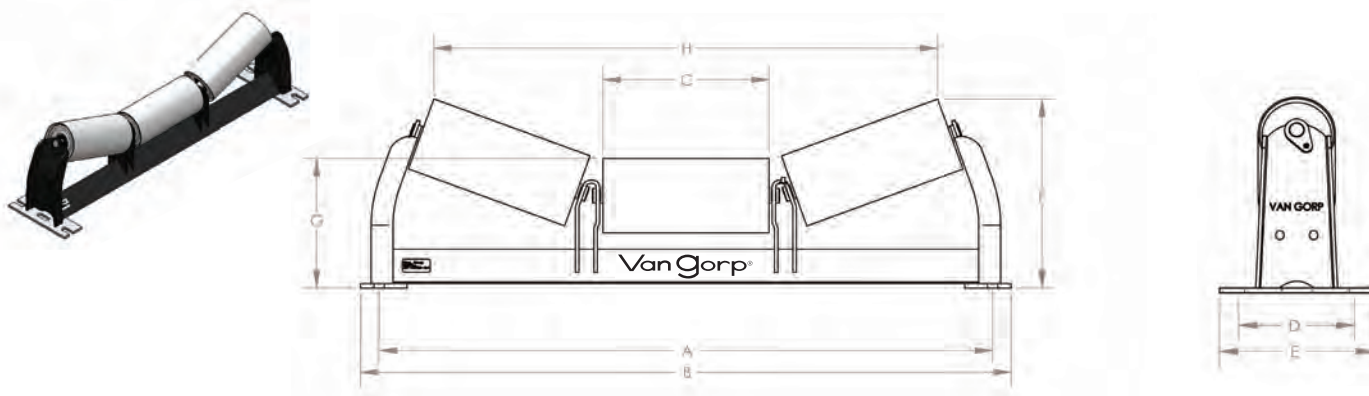

E7 Equal Troughing Idlers

Assembly Description	Belt Width	A	B	C	D	E	F	G	H	Assembly Weight
E7-20TE-36	36	45	49	13	7.5	12	15.88	11.25	39.38	141
E7-20TE-42	42	51	54.75	15	7.5	12	16.56	11.25	45.13	154
E7-20TE-48	48	57	62.63	17.75	7.5	12	17.50	11.25	53.06	168
E7-20TE-54	54	63	68.38	19.75	7.5	12	18.19	11.25	58.88	186
E7-20TE-60	60	69	74.25	21.75	7.5	12	18.88	11.25	64.56	199
E7-20TE-66	66	75	79.88	23.75	7.5	12	20.25	12	70.31	237
E7-20TE-72	72	81	85.88	25.75	7.5	12	20.94	12	76.13	252
E7-35TE-36	36	45	49	13	7.5	12	18.75	11.25	34.75	142
E7-35TE-42	42	51	54.75	15	7.5	12	19.88	11.25	40.06	155
E7-35TE-48	48	57	62.63	17.75	7.5	12	21.50	11.25	47.31	173
E7-35TE-54	54	63	68.38	19.75	7.5	12	22.63	11.25	52.63	186
E7-35TE-60	60	69	74.25	21.75	7.5	12	23.75	11.25	57.88	199
E7-35TE-66	66	75	79.88	23.75	7.5	12	25.69	12	63.13	236
E7-35TE-72	72	81	85.88	25.75	7.5	12	26.81	12	68.44	251

E7 Impact Troughing Idlers

Assembly Description	Belt Width	A	B	C	D	E	F	G	H	Assembly Weight
E7-20TEI-36	36	45	49	13	7.5	12	15.88	11.25	39.38	186
E7-20TEI-42	42	51	54.75	15	7.5	12	16.56	11.25	45.13	209
E7-20TEI-48	48	57	62.63	17.75	7.5	12	17.50	11.25	53.06	242
E7-20TEI-54	54	63	68.38	19.75	7.5	12	18.19	11.25	58.88	266
E7-20TEI-60	60	69	74.25	21.75	7.5	12	18.88	11.25	64.56	286
E7-20TEI-66	66	75	79.88	23.75	7.5	12	20.25	12	70.31	333
E7-20TEI-72	72	81	85.88	25.75	7.5	12	20.94	12	76.13	385
E7-35TEI-36	36	45	49	13	7.5	12	18.75	11.25	34.75	190
E7-35TEI-42	42	51	54.75	15	7.5	12	19.88	11.25	40.06	214
E7-35TEI-48	48	57	62.63	17.75	7.5	12	21.50	11.25	47.31	247
E7-35TEI-54	54	63	68.38	19.75	7.5	12	22.63	11.25	52.63	271

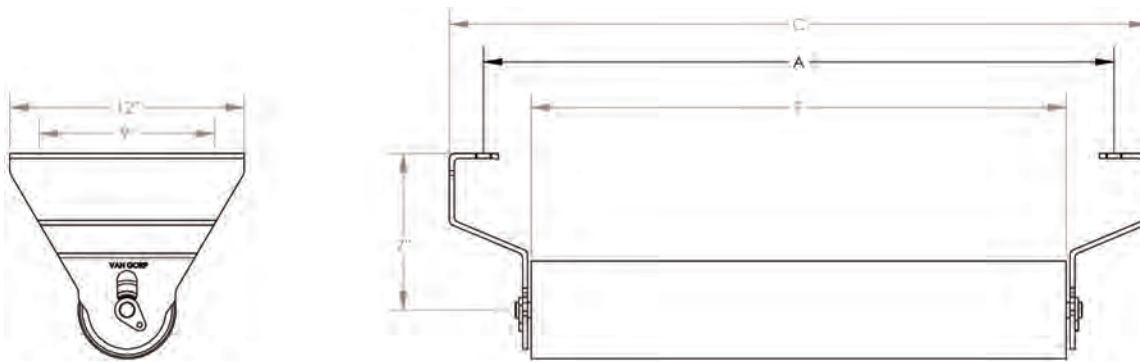

E7 Return Idlers

Assembly Description	Belt Width	A	C	F	Assembly Weight
E7-7R-36	36	45	48	40	82
E7-7R-42	42	51	54	46	92
E7-7R-48	48	57	60	52	101
E7-7R-54	54	63	66	58	110
E7-7R-60	60	69	72	64	118
E7-7R-66	66	75	78	70	127
E7-7R-72	72	81	84	76	136

Standard End Stand for Flat Carrier Idlers

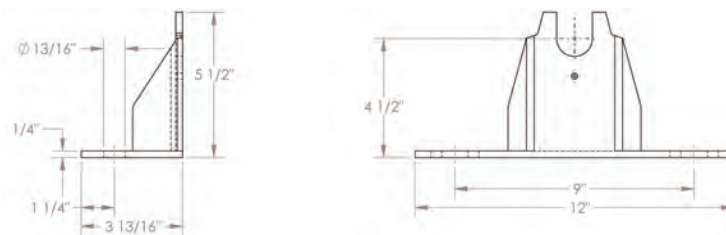

Van Gorp

1410 Washington St
PO Box 288
Pella, IA 50219
(641) 628-9212
www.vangorp.biz

MEMBER:



NSSGA



GOODYEAR
GOODYEARBELTING.COM

Call Toll Free: 1-866-711-4673
International: +1-727-342-5086

**We Ship
World Wide**

Van Gorp®

The Take-Up Place

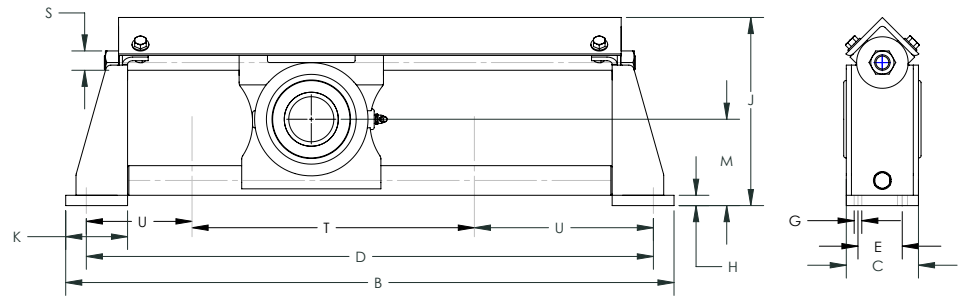

Top Angle Take-up Frame

Frame Size	Travel	Wt. lbs.	Part No.	Dimensions													
				B	C	D	E	F Bolt Dia	G	H	J	K	M	R	S	T	U
TA200	12	26	9047887	28 1/2	3 1/2	26 1/2	-	5/8	1	1/2	8 1/2	3	3 15/16	6 5/16	3/4	14	6 1/4
	18	31	9047895	34 1/2		32 1/2										20	
	24	34	9047903	40 1/2		38 1/2										26	
TA203	12	34	9047911	29 1/2	3 1/2	27 1/2	-	5/8	1	1/2	9 1/8	3	4 3/16	6 15/16	3/4	14 3/4	6 3/8
	18	40	9047929	35 1/2		33 1/2										20 3/4	
	24	45	9047937	41 1/2		39 1/2										26 3/4	
TA208	12	45	9047945	30 1/2	4	28 1/2	-	3/4	1 5/16	1/2	10	3 1/2	4 3/8	7 3/8	1	14	7 1/4
	18	52	9047952	36 1/2		34 1/2										20	
	24	59	9047960	42 1/2		40 1/2										26	
	30	67	9047978	48 1/2		46 1/2										32	
	36	73	9047986	54 1/2		52 1/2										38	
TA300	12	50	9047994	32 1/2	4 1/2	30 1/2	2	5/8	1	1/2	11	3 1/2	4 15/16	8 3/8	1	15	7 3/4
	18	56	9048000	38 1/2		36 1/2										21	
	24	63	9048018	44 1/2		42 1/2										27	
	30	70	9048026	50 1/2		48 1/2										33	
	36	76	9048034	56 1/2		54 1/2										39	
TA308	12	58	9048042	34 1/2	4 1/2	32	2	3/4	1	1/2	12 3/8	4	5 7/16	9 3/8	1 1/4	14 1/2	8 3/4
	18	65	9048059	40 1/2		38										20 1/2	
	24	73	9048067	46 1/2		44										26 1/2	
	30	79	9048075	52 1/2		50										32 1/2	
	36	87	9048083	58 1/2		56										38 1/2	
	42	95	9048091	64 1/2		62										44 1/2	
	48	102	9048109	70 1/2		68										50 1/2	
TA400	12	86	9048117	38 1/2	5 1/2	36	2 1/2	3/4	1	3/4	14 1/2	4 1/2	7	11 5/16	1 1/4	15 1/2	10 1/4
	18	94	9048125	44 1/2		42										21 1/2	
	24	102	9048133	50 1/2		48										27 1/2	
	30	111	9048141	56 1/2		54										33 1/2	
	36	119	9048158	62 1/2		60										39 1/2	
	42	127	9048166	68 1/2		66										45 1/2	
	48	135	9048174	74 1/2		72										51 1/2	

The Top angle protects the screw from dirt and damage (some place on front page)
 Type of manufacturer's pillow block and number of mounting holes should be stated on purchase order.
 For sizes of take-up frames not listed, contact Van Gorp Engineering Department.



Call Toll Free: 1-866-711-4673
International: +1-727-342-5086



Van Gorp®

The Take-Up Place

1410 Washington St
PO Box 288
Pella, IA 50219
www.vangorp.biz

Take-UP Frame Interchange	
Van Gorp	Dodge
TA-200	TP-10
TA-203	TP-20
TA-208	TP-30
TA-300	TP-40
TA-308	TP-50
TA-400	TP-60

Frame Size	Typical Shaft Size	Bearing Bore Ranges
TA-200	1 15/16	1 3/4 - 2
TA-203	2 3/16	2 3/16
TA-208	2 7/16	2 1/4 - 2 1/2
TA-300	2 15/16	2 11/16 - 3
TA-308	3 7/16	3 3/16 - 3 1/2
TA-400	3 15/16	3 15/16 - 4

Van Gorp Top Angle frames are for use with Dodge top angle take-up bearings for types GLT,H,G,GXR GM,E,K, and TP S2000

ISO Certified for World Class Quality

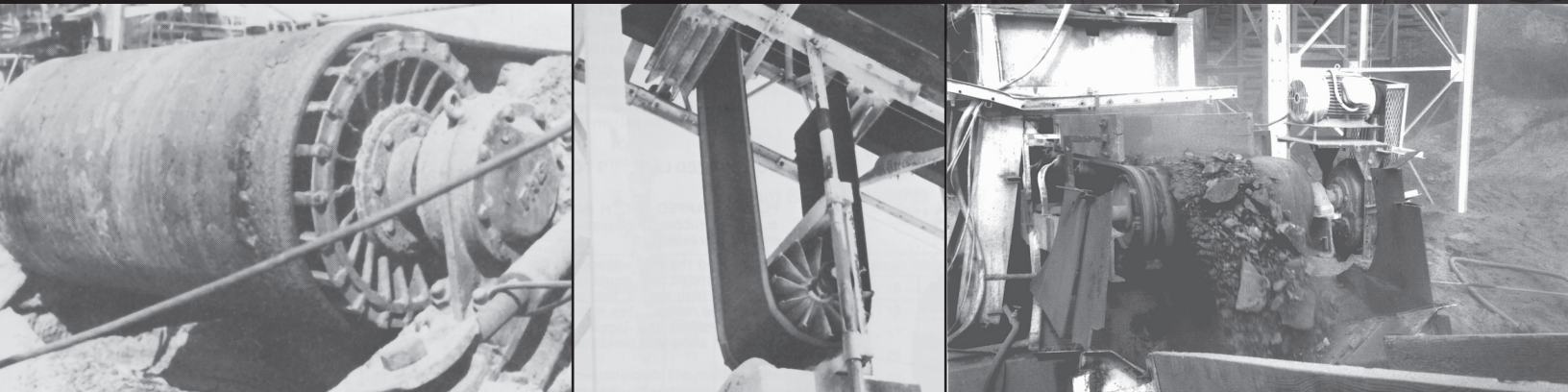

Call 1-800 VAN GORP for all of your conveyor pulley and take-up frame needs!

Distributed by:

GOODYEAR
GOODYEARBELTING.COM

Call Toll Free: 1-866-711-4673
International: +1-727-342-5086

We Ship
World Wide

Van Gorp®

The Take-Up Place

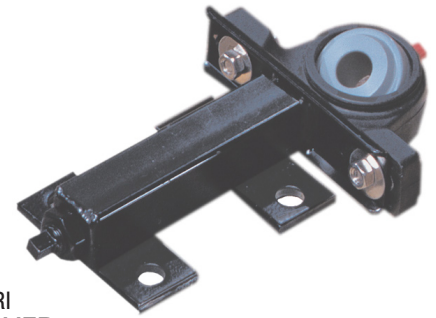
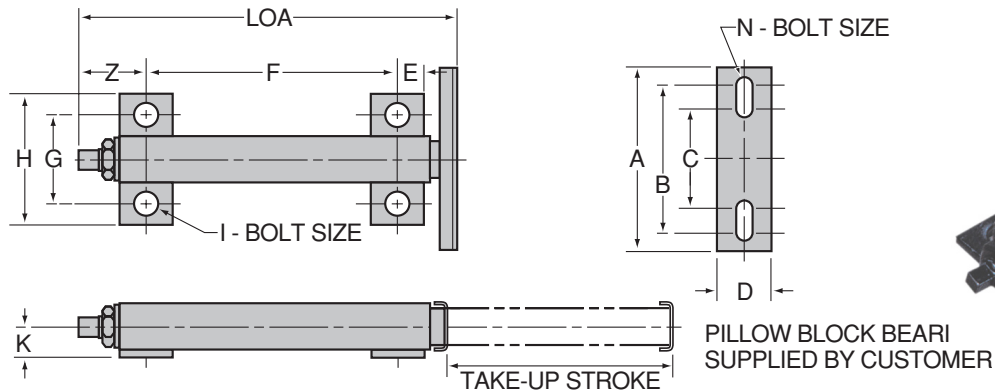

Telescoping Take-up Frame

HOW TO SPECIFY AND ORDER						STANDARD TAKE-UP DIMENSIONS (INCHES)																	
BEARING BORE RANGE	TUBE SERIES	TAKE UP STROKE	MATERIAL	MTG. FEET	BEARING PLATE	LOA	K	BEARING PLATE DIMENSIONS					FOOT DIMENSIONS					SQ. TUBE SIZE		ADJUSTER			
								A	B	C	D	N BOLT	E	F	G	H	I BOLT	Z	SLIDER	BODY	SQ DRIVE	THD. UNC.	
1/2" TO 1"	100	3	MS	SF	BP	6.88	0.88	5.25	4.31	2.94	1.50	3/8	0.75	3.56	2.63	3.69	1/2	1.84	1.00	1.25	WELD NUT 15/16 HEX	.625-11	
		6				10.38								7.06									11.06
		9				14.38								11.06									11.06
3/4" TO 1 3/4"	250	3	MS	SF	BP	8.50	1.13	7.00	5.69	3.81	2.04	1/2	1.00	4.38	3.00	4.00	1/2	2.25	1.50	1.75	WELD NUT 1 1/8 HEX	.75-10	
		6				11.50								7.38									10.38
		9				14.50								10.38									13.38
		12				17.50								13.38									13.38
1 3/4" TO 2 15/16"	300	6	MS	SF	BP	11.13	1.50	10.00	8.69	5.56	2.84	5/8	1.25	6.12	4.00	5.25	5/8	2.63	2.25	2.50	WELD NUT 1 5/16 HEX	.875-9	
		9				15.13								10.12									14.12
		12				19.13								14.12									21.12
		18				26.13								21.12									21.12
1 3/4" TO 2 15/16"	350 HD	9	MS	SF	BP	19.00	1.75	10.00	8.69	5.56	3.00	5/8	1.25	13.00	4.50	5.75	5/8	3.50	2.50	3.00	WELD NUT 1 7/16 HEX	.875-6 ACME	
		12				22.00								16.00									22.00
		18				28.00								22.00									28.00
		24				34.00								28.00									28.00
2 7/16" TO 3 1/2"	400	12	MS	SF	BP	27.75	2.13	14.00	11.75	8.50	3.50	3/4	1.75	20.00	5.50	7.50	3/4	4.25	3.00	3.50	WELD NUT 2 HEX	1.25-5 ACME	
		18				33.75								26.00									32.00
		24				39.75								32.00									32.00

Easy 4-bolt assembly to channel bed

Uses standard 2-bolt pillow block bearing on pillow block bearings

Sturdy, simple modular design for troublefree operation

Threaded internal adjuster rod is totally enclosed and protected against product buildup, rust, corrosion, or thread damage.

CALL 1-800-VAN-GORP (826-4677) for all of your Take-Up needs! Or email vangorp@vangorp.biz

GOODYEAR
GOODYEARBELTING.COM

Call Toll Free: 1-866-711-4673
International: +1-727-342-5086

We Ship
World Wide

Top Mount Take-up Frame

MODEL	UNIT DIMENSIONS:			TUBE SIZES			ADJUSTER ROD SIZES
	TAKE UP STROKE	A	B	BT	TS1	TS2	
350TM	9	28.75	26.00	3.00	3.50	2.50	.875-6 ACME
	12	31.75	29.00				
	18	37.75	35.00				
	24	43.75	41.00				
	30	49.75	47.00				
	36	55.75	53.00				
400TM	9	34.25	31.50	3.50	4.00	2.75	1.250-5 ACME
	12	37.25	34.50				
	18	43.25	40.50				
	24	49.25	46.50				
	30	55.25	52.50				
	36	61.25	58.50				
500TM	9	51.75	46.75	6.00	7.00	5.00	2.250-4 ACME
	12	54.75	49.75				
	18	60.75	55.75				
	24	66.75	61.75				
	30	72.75	67.75				
	36	78.75	73.75				

MOUNTING DIMENSIONS										
MODEL	FA	FB	FC	FD	FE	FF	FG	FH	FJ	FK
350TM	3.00	1.63	4.00	2.50	0.75	0.75	2.00	4.00	5.25	1.24
400TM	3.50	2.13	5.00	3.00	1.00	0.88	2.82	5.00	6.50	1.36
500TM	6.00	3.50	7.50	5.00	1.25	0.88	4.25	8.00	9.93	1.76

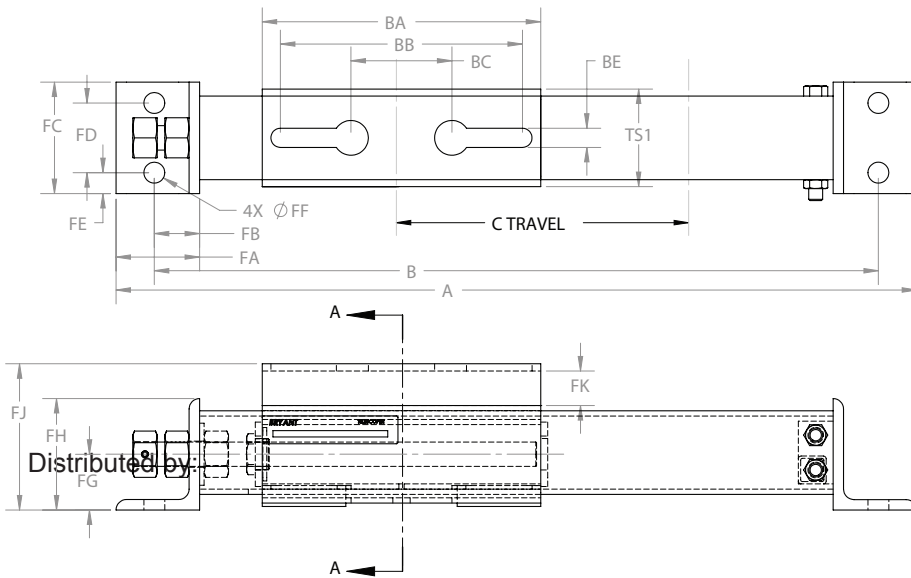

BEARING PLATE DIMENSIONS				
BA	BB	BC	BD	BE
10.00	8.69	5.56	0.69	1.75
14.00	11.75	8.50	1.00	2.00
22.00	per customer specifications			

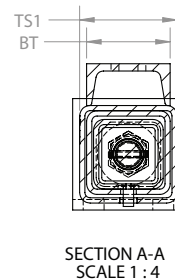

WARRANTY

Two year no freeze-up guarantee standard
-or-
Five year no freeze-up guarantee with addition of grease fitting

ISO Certified for World Class Quality

Call 1-800-VAN-GORP for all of your conveyor pulley and take-up frame needs!

1410 Washington St
PO Box 288

GOODYEAR
GOODYEARBELTING.COM

Call Toll Free: 1-866-711-4673
International: +1-727-342-5086

**We Ship
World Wide**