



Materials Handling

Habasit Belts for

- Distribution/Warehousing
- General Conveying

Habasit—Solutions in motion



Materials Handling trends and requirements

At Habasit we focus all our efforts on the demands of our customers. The changes in the Materials Handling industry lead to a continuous increase of requirements, such as:

- Optimum system availability
- High reliability
- System speed
- Low noise operations
- Short turnaround time
- Highly automated systems
- Modular systems
- System flexibility

Dedicated to Materials Handling

In Materials Handling from storage and commissioning to sorting and general locomotion of goods, you will find Habasit belting solutions in virtually every belt application. Thanks to our highly qualified specialists, our specific industry know-how, and continuous research and development, Habasit is successful in providing a complete product range which suits the needs of the Materials Handling industry like:

- One stop shop
- Customized systems in modular design
- Reduced installation time
- Easy maintenance
- Endurance to operate around the clock
- Reduced down times
- Easy retrofitting

Contents

Introduction	2-3
Sorting system overview (schematic)	4-5
Single application overview	6-7
Variety of product ranges	8a
Variety of surfaces/styles of fabric-based belts	8
Variety of surfaces/styles of plastic modular belts	9
Materials handling applications table/belt selection guide/key data	10-11
Part A: PVC coated belts	
Materials handling applications table/belt selection guide/key data	12-13
Part B: TPU coated belts, Nonwoven belts, Impregnated fabric belts, Rubber coated belts	
Materials handling applications table/belt selection guide/key data	14-15
Part C: Plastic modular belts, Power transmission belts, Round belts	
Features and benefits	16-23
Services (general services/customized services)	24-25
The Habasit Solution	27



The complete belting offer

- **Fabric conveyor belts** are available with various coating materials like TPU, PUR, PVC or rubber, as well as with various surface structures including nonwoven. This is why we are able to offer the most suitable belt for your specific application requirements.
- **HabasitLINK® plastic modular belts** are available in different materials like **PP, PE, POM/AC, PA as well as special materials** and a large variety of different belt styles. Habasit is the only belt supplier to manufacture and offer the full package of fabric-based belts **and** plastic modular belts.
- **Power transmission belts and machine tapes** are available, tailor made to suit the specific needs e.g. as drive belts for live roller conveyors. This includes round belts, which can be used as live roller belts.
- **Accessories** like profiles, v-guides and cleats complete our offering.

Innovation is a key word at Habasit

The extensive variety of solutions enables our customers to choose the best product for their application.

Competence and experience

Habasit application engineers, technicians and joining specialists are at your disposal to provide professional consulting, superb customer service and excellent support. Since its foundation in 1946, Habasit has proven this understanding of customer needs for more than 50 years.

With a comprehensive global network, Habasit is able to respond to any request that you may have with nothing less than an outstanding belting solution of highest quality, tailored to your specific needs.





Crossbelt sorter

Live roller conveyor

Tilt-tray sorter

Vertical sorter

Power turn

Round belt conveyor

Gapping conveyors

Shoe sorter

Z-conveyor

Pusher sorter

Paddle diverter

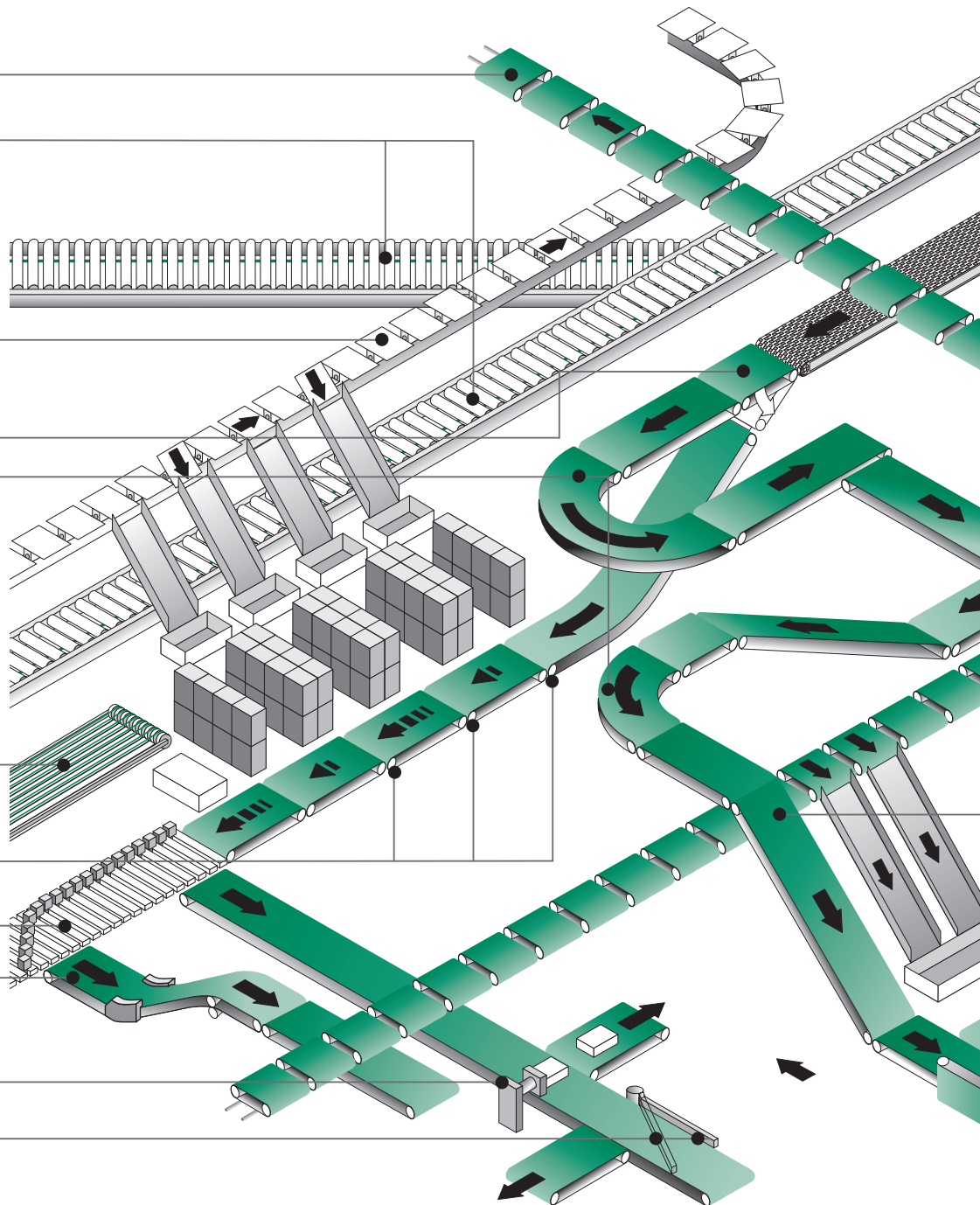

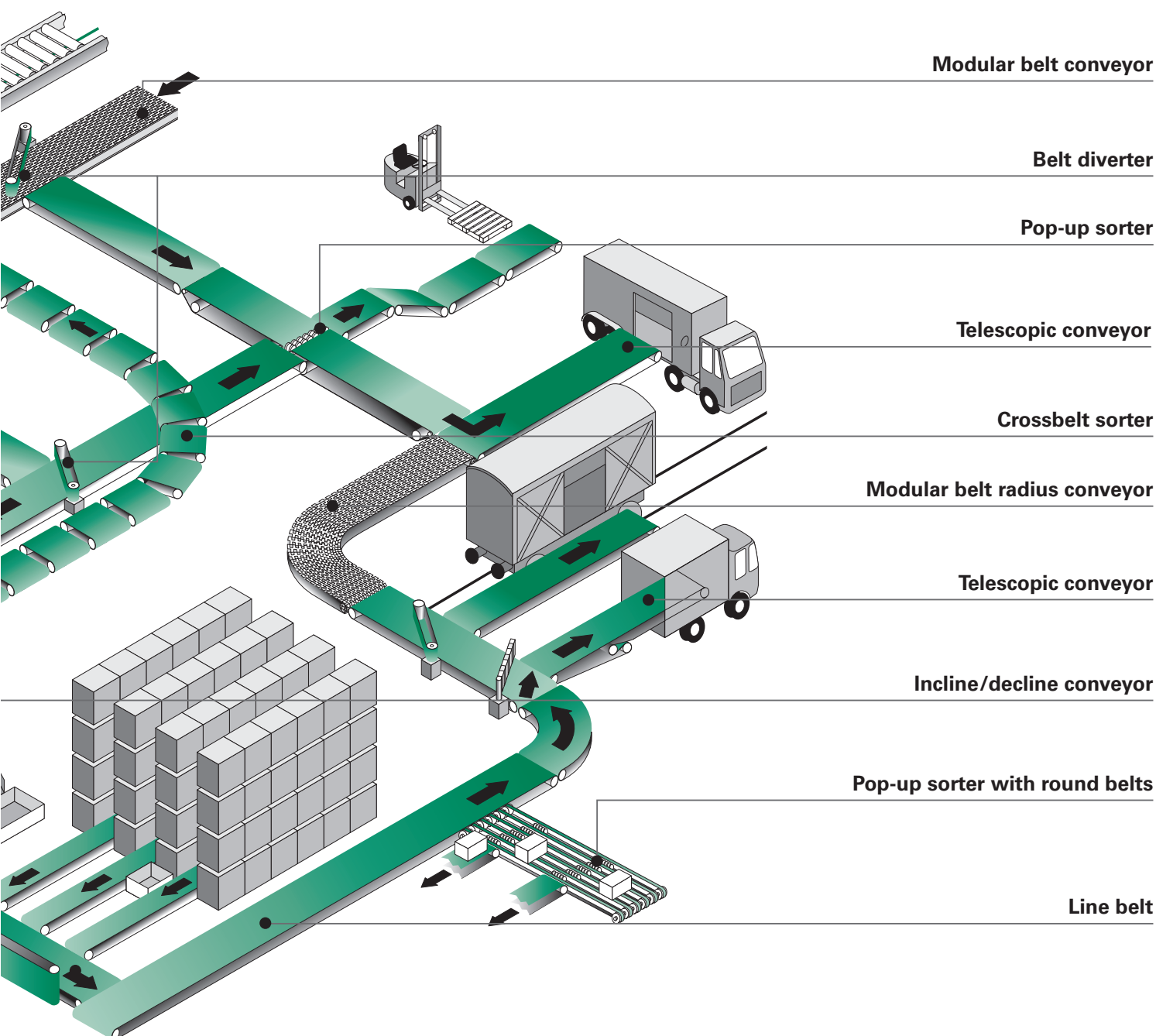

Remark: The drawings show schematic examples of selected applications/processes. The drawings don't lay claim to completeness. The belt recommendations (use/application/layout) can only be considered as a general hint. Due to the complexity of the various processes and technical requirements and the decisive external influences (e.g. nature or property of transported goods, process speed, steps of treatment/handling, environment or process temperature

Input stage

1

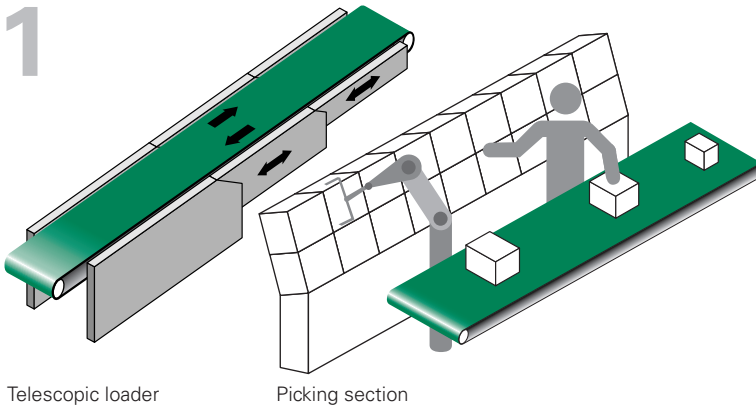

Accumulation, gapping

2

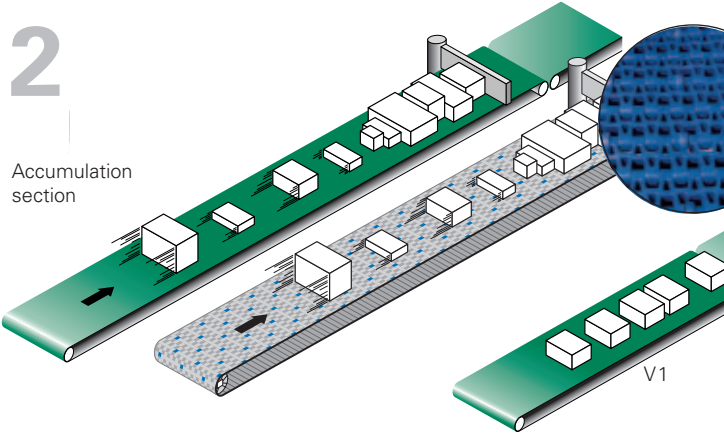

Induction to sorter, sorter

Crossbelt sorter with feeder, metering and induction

4

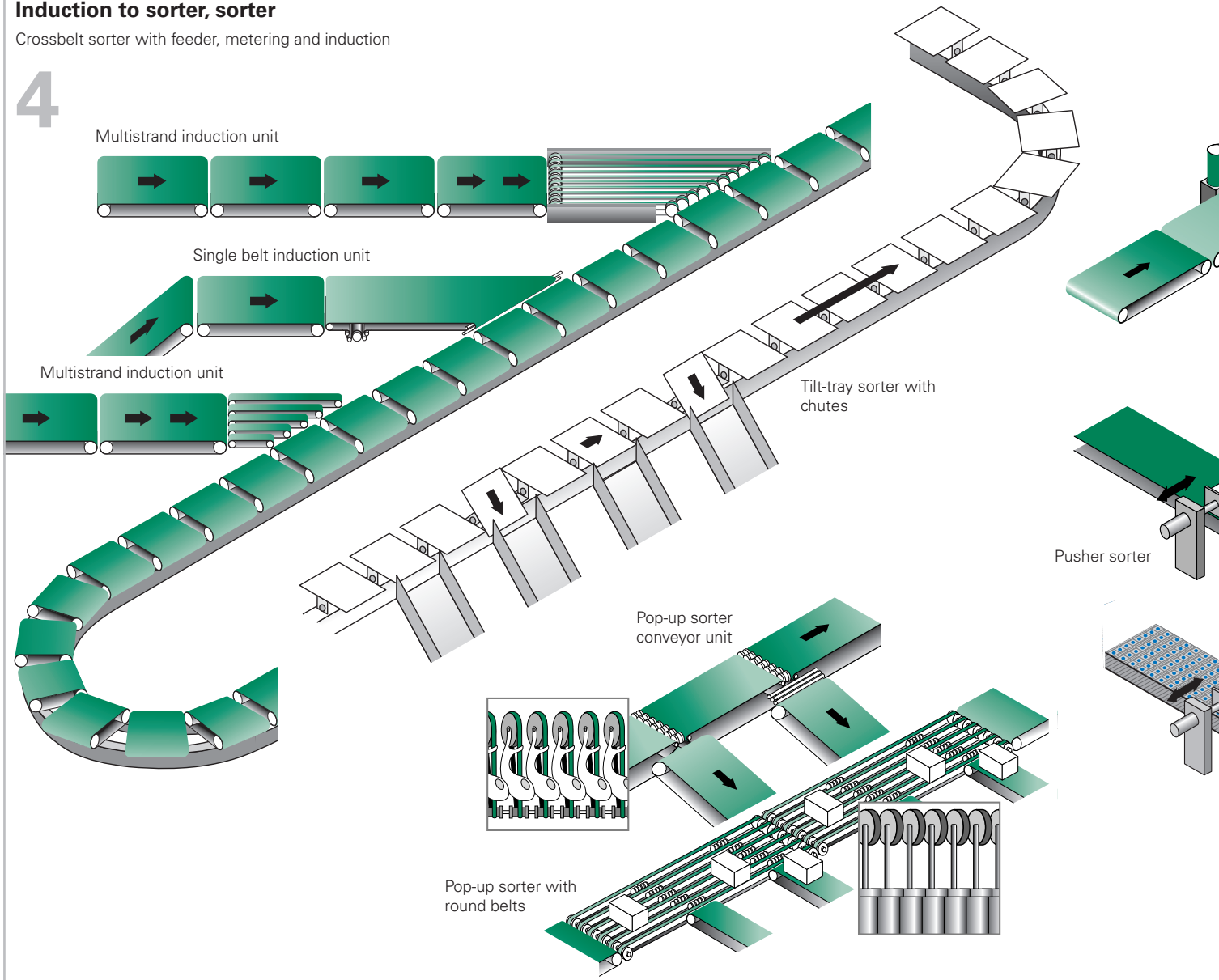

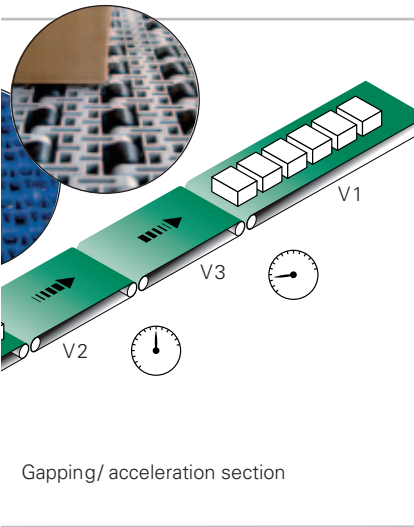

Gapping/ acceleration section

Identification

3

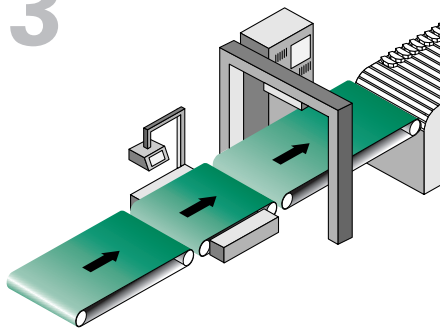

Check weigher, scale, scanner, labeling section

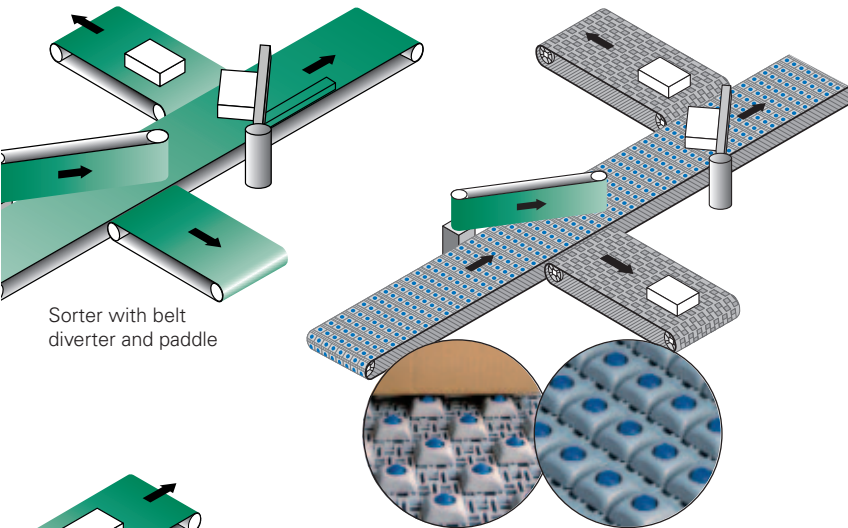

Sorter with belt diverter and paddle

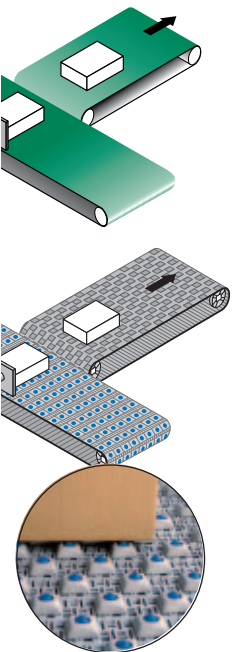

Outfeed, final stage

Deceleration belts

5

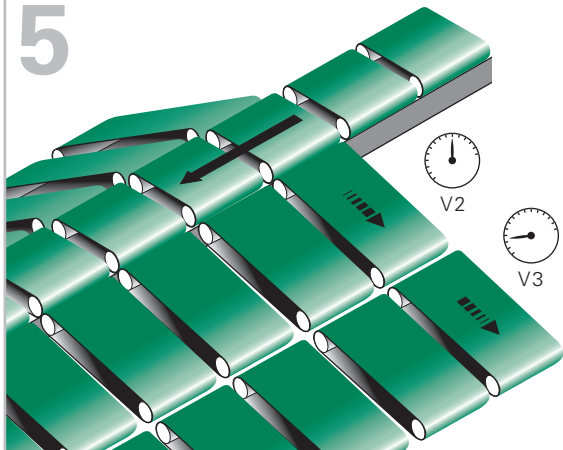

Conveyor sub systems, conveyor modules

Various live roller conveyors

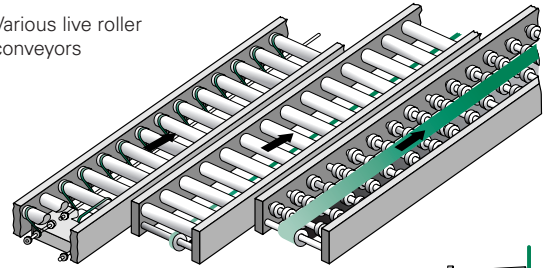

Live roller curve with round belt

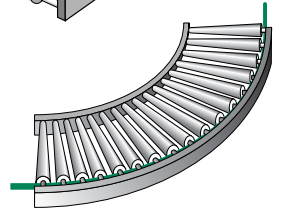

Power turn

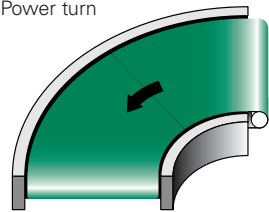

Modular belt radius conveyor

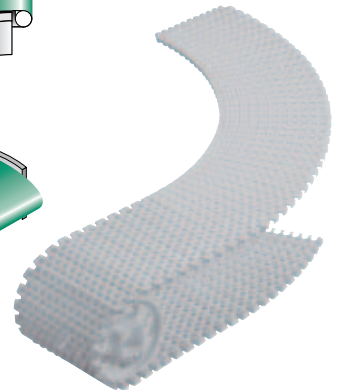
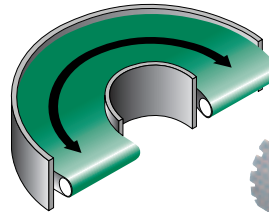

Z-conveyor/goose neck conveyor

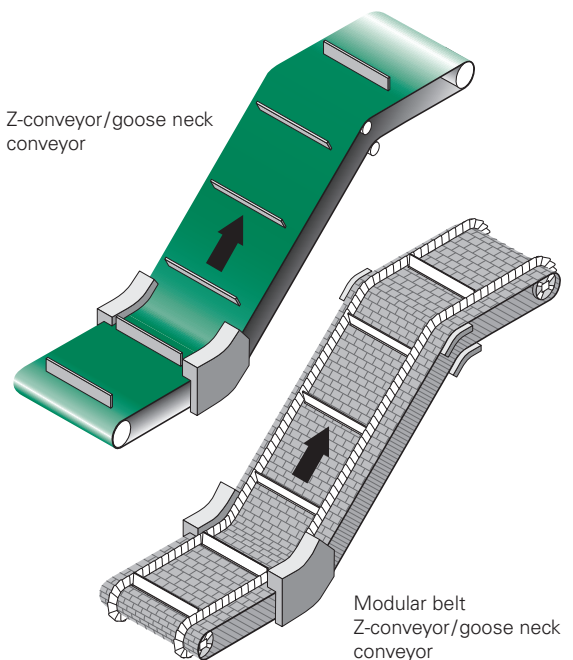

Modular belt Z-conveyor/goose neck conveyor

The right choice

Habasit has developed an extensive variety of solutions that allow customers to choose the best belting product for their specific application. Habasit is the only belt supplier who manufactures and offers the full package of fabric based belts and plastic modular belts.

Belting products for Materials Handling applications

Design/Materials/Components variations

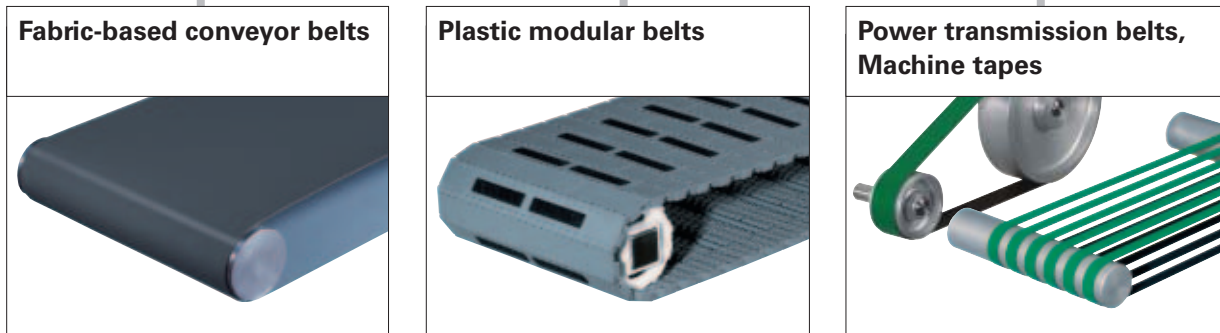

Fabric-based conveyor belts

Plastic modular belts

Power transmission belts, Machine tapes

- PVC coated**
- N-Line
 - Standard line

- PP**
(Polypropylene)

- Polyester reinforced**
- TC-, TCF-series
 - CM-series

- TPU coated**
- High duty line
 - Extraline

- PE**
(Polyethylene)

- Armid reinforced**
- TF-series

- Nonwoven**
- G series

- POM/AC**
(Polyoxymethylene/Acetal)

- Round belt**
- Polycord
 - Habicord

- Impregnated fabric belts**
- NNT-series
 - SNI-series
 - ENI-series

- PA**
(Polyamide)

Detailed characteristics, belt features and customer benefits you will find after the belt application overview.

- Flame retardant belts**
- N-Line
 - Nonwoven

- Special materials**
(e.g. electrically conductive, detectable, flame retardant, high temperature materials, etc.)

- Rubber coated**
- High duty line

Modular belts are suitable for logistics, packaging, warehousing, general conveying, etc.

Detailed characteristics, belt features and customer benefits you will find after the belt application overview.

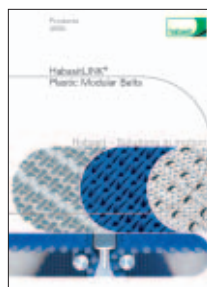

Please consult product brochure 4000 HabasitLINK®, plastic modular belts for details/further information.

Klappseite 186mm gemäss Schnittzeichen

Klappseite 186mm gemäss Schnittzeichen

GOODYEAR
GOODYEARBELTING.COM

Call Toll Free: 1-866-711-4673
International: + 1-727-342-5086

We Ship
World Wide

Variety of surfaces/styles of fabric-based belts (selection only)

Belt surface or style

To fulfill a specific application need, a process requirement or a defined function the belt surface/style or the material inherent properties play a key role. See following some of the variety of surfaces, styles and properties.

Pictures: Product view from top and bird's view (running direction from left to right).

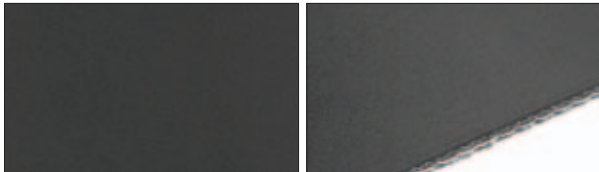

Blank smooth surface

Available properties: Adhesive, Medium adhesive, Super adhesive, Non-adhesive

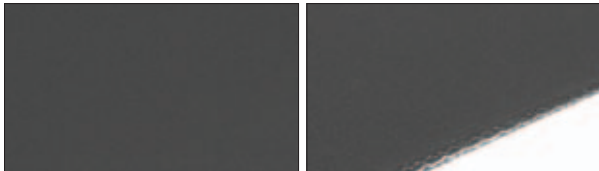

Super mat finish (sand finish)

Available property: Non-adhesive

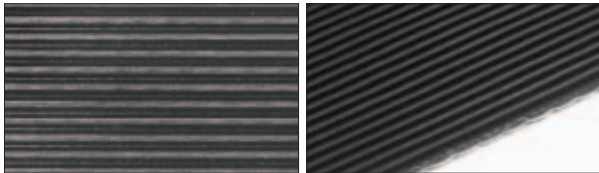

Longitudinal grooved structure

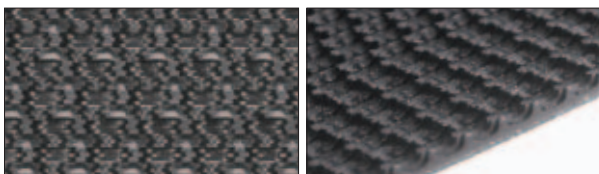

Jink wave (sine wave) grip structure

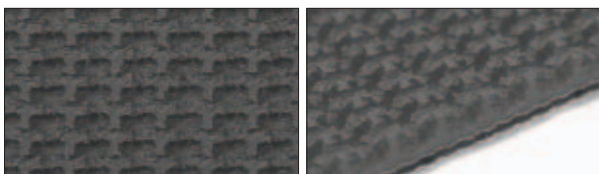

Grip structure

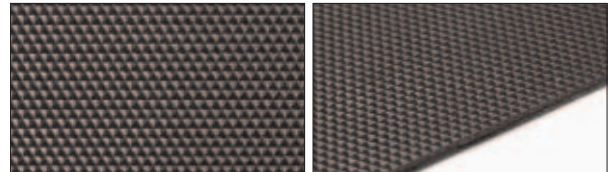

Waffle structure (negative pyramid)

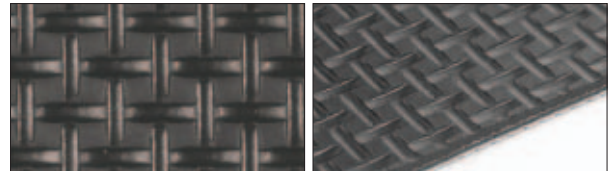

Quadrillé (quadrangular) structure

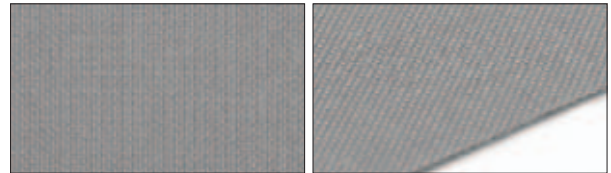

Impregnated fabric surface (fine or rough structure)

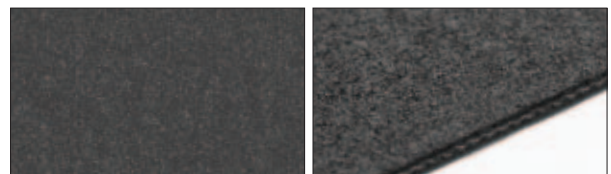

Nonwoven (fleece) structure

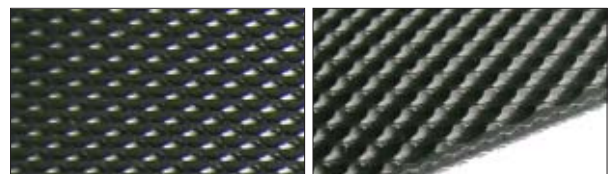

Elliptical smooth netting structure (either positive or negative)

Variety of surfaces/styles of plastic modular belts (selection only)

Belt surface or style

To fulfill a specific application need, a process requirement or a defined function the belt surface/style or the material inherent properties play a key role. See following some of the variety of surfaces, styles and properties.

Pictures: Product view from top and bird's view (running direction from left to right)

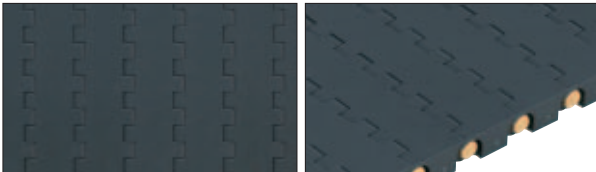

Flat Top
For straight conveying



Roller Top - 45°
For straight conveying/45° transfer/alignment/
centering

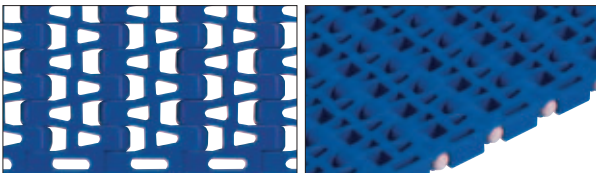

Flush Grid
For straight conveying, air flow/high air
permeability/excellent for cooling

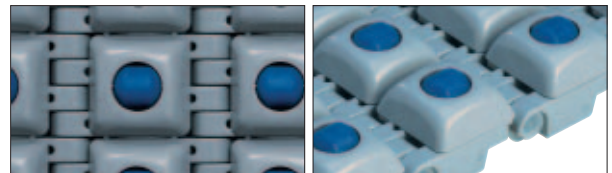

Roller Top - 90°
For straight conveying/90° transfer
(transversal movement)



Radius Grip Top
For straight and radius conveying/inclined/
declined

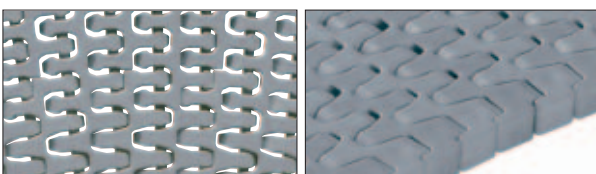

Standard and Tight Radius*
For straight and radius conveying. *Tight Radius
= 1.6 collapse factor requires 30% less space!



H-ChainLINK® Series: Knuckle Chain
For straight conveying/heavy duty

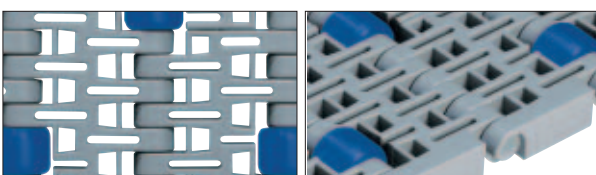

Roller Top
For straight conveying/accumulation/
separation



H-ChainLINK® Series: Knuckle Chain Radius
For straight and radius conveying, heavy duty

Klappseite 186mm gemäss Schnittzeichen

GOODYEAR
GOODYEARBELTING.COM

Call Toll Free: 1-866-711-4673
International: + 1-727-342-5086

We Ship
World Wide



Features and benefits

PVC coated belts

PVC coated fabric belts

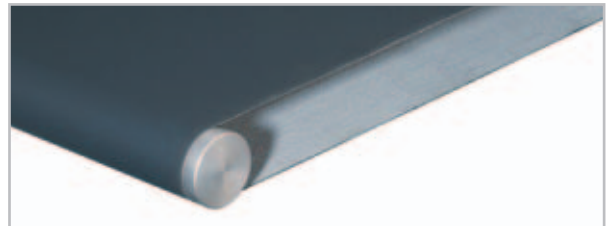
Preferred solution for Materials Handling with excellent cost-value ratio for general conveying purposes.

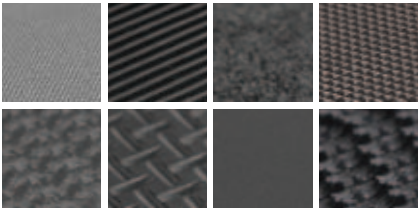
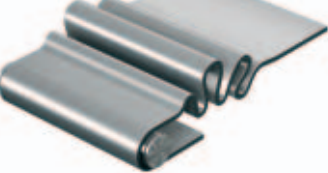
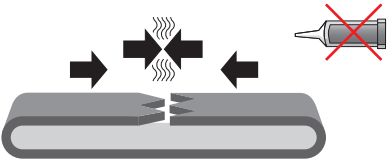

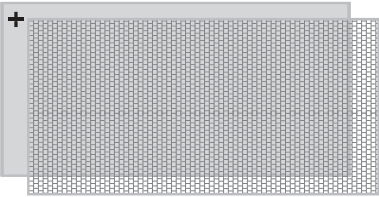
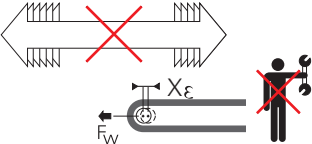
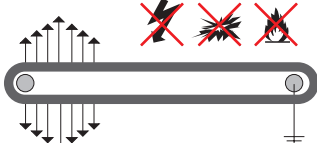
	Benefits
 <ul style="list-style-type: none"> • A wide range of various surface types, structures and belt strengths 	<ul style="list-style-type: none"> → Right conveyor belt for a specific application → Cost "friendly" solutions
 <ul style="list-style-type: none"> • Longitudinal flexibility 	<ul style="list-style-type: none"> → Belt can cope with small pulley diameters, compact design → Long belt life
 <ul style="list-style-type: none"> • Simple and fast joining method (Flexproof) 	<ul style="list-style-type: none"> → Easy handling → Adhesive-free joint → Minimum equipment needed → Short machine downtimes
 <ul style="list-style-type: none"> • Flame retardant belts available (DIN 22103, ISO 340) 	<ul style="list-style-type: none"> → No spreading of fire to other buildings → Increased safety for people, buildings and installations
 <ul style="list-style-type: none"> • Impregnated fabric surface available 	<ul style="list-style-type: none"> → Constant low coefficient of friction over entire belt life → Wear resistant belt surface → Less soiling and maintenance → Long service life
 <ul style="list-style-type: none"> • Stable modulus of elasticity after running-in 	<ul style="list-style-type: none"> → No re-tensioning → No downtimes → No maintenance
 <ul style="list-style-type: none"> • Permanently antistatic belting available 	<ul style="list-style-type: none"> → No interference with electronic devices → Less dust and dirt attraction → Process reliability → Low maintenance cost

Features and benefits

TPU coated belts

TPU coated belts

Solution for high demanding applications, e.g. small pulleys and narrow transfer points, extreme temperatures, oily environment, applications which ask for cut and abrasion resistant surfaces.

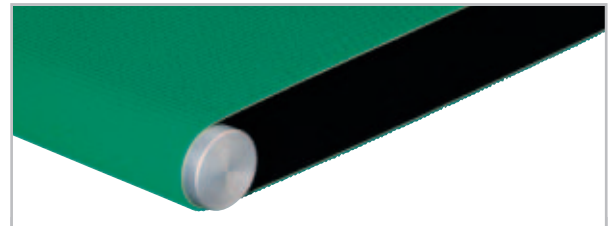

	Features	Benefits
	<ul style="list-style-type: none"> • Calendered TPU coating • A wide range of various surface types and structures 	<ul style="list-style-type: none"> → Abrasion- and cut-resistant belt surface → Constant coefficient of friction over entire belt lifetime → Long belt life
	<ul style="list-style-type: none"> • Longitudinal flexibility 	<ul style="list-style-type: none"> → Belt can cope with small pulley diameters, compact design → Smooth and trouble-free product transfer → Low energy consumption
	<ul style="list-style-type: none"> • Excellent abrasion resistance • Constant coefficient of friction 	<ul style="list-style-type: none"> → Reliable conveying properties → No plasticizer migration → No marking of goods → Long belt life
	<ul style="list-style-type: none"> • Low temperature resistant 	<ul style="list-style-type: none"> → No cracking of belt surface → Remains flexible at low temperature → Long belt life
	<ul style="list-style-type: none"> • Stable modulus of elasticity after running-in 	<ul style="list-style-type: none"> → No re-tensioning → No downtimes → No maintenance
	<ul style="list-style-type: none"> • Light weight belt construction/ design for heavy duty 	<ul style="list-style-type: none"> → Low belt weight/mass → Suitable for high speeds and rapid acceleration → Low energy consumption
	<ul style="list-style-type: none"> • Permanently antistatic belting available 	<ul style="list-style-type: none"> → No interference with electronic devices → Less dust and dirt attraction → Process reliability → Low maintenance cost

Features and benefits

Nonwoven belts

Nonwoven belts

The nonwoven construction (polyester web/fleece PET) is particularly suitable for materials handling applications under rough and rugged conditions.



	Features	Benefits
	<ul style="list-style-type: none"> • Impact- and wear-resistant nonwoven design • Damping capability of belt 	<ul style="list-style-type: none"> → Durable and forgiving belt surface thanks to nonwoven construction → Excellent damper/buffer for conveyed goods thanks to thickness → Gentle, soft and safe handling of conveyed goods → Reduced cost for rejects → Extended belt service life
	<ul style="list-style-type: none"> • Superior edge fray resistance 	<ul style="list-style-type: none"> → No stringing or fraying of belt that runs against side of conveyor → Extended belt service life
	<ul style="list-style-type: none"> • Excellent flexibility in spite of greater thickness 	<ul style="list-style-type: none"> → Excellent ratio pulley diameter/belt thickness → Can handle relatively small pulley diameters → Lower power consumption
	<ul style="list-style-type: none"> • Low noise design 	<ul style="list-style-type: none"> → Substantially reduced noise on slider bed → Nonwoven inherent noise absorption capability → Comfortable working environment (e.g. public areas)
	<ul style="list-style-type: none"> • Good fastener retention 	<ul style="list-style-type: none"> → Highly appropriate for mechanical joining/lacing
	<ul style="list-style-type: none"> • Permanently antistatic belting available 	<ul style="list-style-type: none"> → No interference with electronic devices → Less dust and dirt attraction → Process reliability → Low maintenance cost

Features and benefits

Rubber coated belts

Rubber coated belts (EPDM)

The rubber (ethylene-propylene-terpolymer) coated belts ensure excellent grip and abrasion resistance. A superior belt performance is ensured where high friction and damping features are decisive. Rubber coated belts are suitable for inclined, declined and horizontal conveying, as well as for gapping, metering, singulation and acceleration applications.

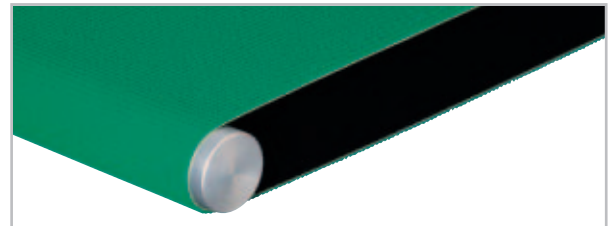

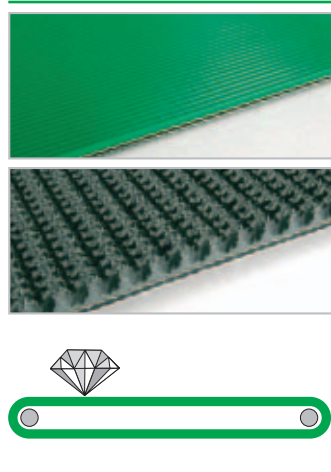
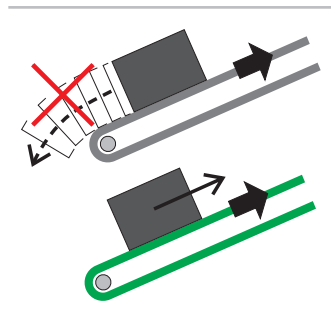
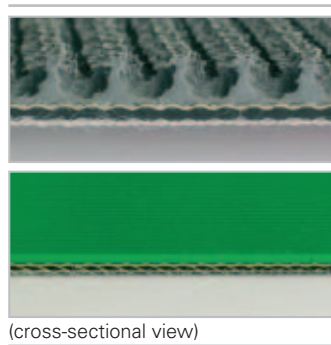
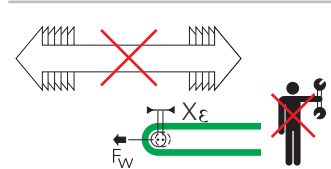
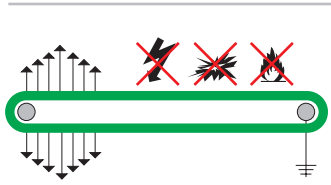
	Features	Benefits
	<ul style="list-style-type: none"> • High grip rubber (EPDM) 	<ul style="list-style-type: none"> → Constant coefficient of friction during entire lifetime of belt → Durable and abrasion resistant rubber belt surface → Reliable product flow in acceleration sections → Long service life
	<ul style="list-style-type: none"> • Incline/decline suitable 	<ul style="list-style-type: none"> → Reliable product flow in critical applications like inclines/declines → No jams, no downtimes
 <p>(cross-sectional view)</p>	<ul style="list-style-type: none"> • Rubber inherent damping capability 	<ul style="list-style-type: none"> → Gentle, soft and safe handling of conveyed goods → Reduced costs for rejects
	<ul style="list-style-type: none"> • Stable modulus of elasticity after running-in 	<ul style="list-style-type: none"> → Dimensional stability → No re-tensioning → No downtimes
	<ul style="list-style-type: none"> • Permanently antistatic 	<ul style="list-style-type: none"> → No interference with electronic devices → Less dust and dirt attraction → Process reliability → Low maintenance cost

Features and benefits

Plastic modular belts

Plastic modular belts

Based on our comprehensive experience and our leadership position in traditional fabric-based belting, Habasit has developed the HabasitLINK® modular belt range. This state-of-the-art product line completes our offer as a single source supplier and partner for your success. Plastic modular belts are used successfully in a wide range of applications in material handling and general conveying like straight and/or combined radius transport, inclines, accumulation/separation, pusher sorter with 90° transfer, alignment and centering, and many more.

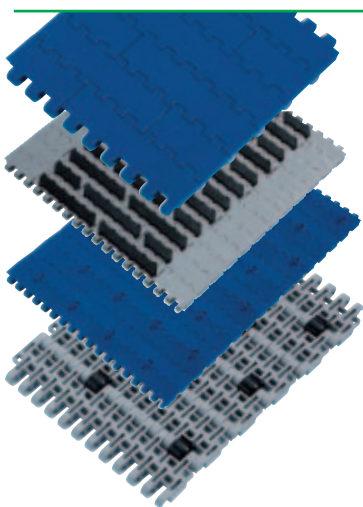
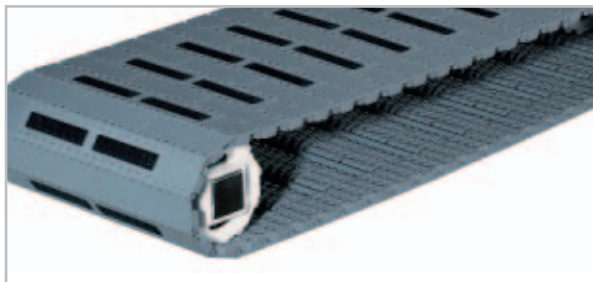

Features

- Large variety of plastic materials and colors available
PP = Polypropylene
PE = Polyethylene
POM/AC = Polyoxymethylene/ Acetal
PA = Polyamide and special materials
- Different module styles, sizes and module strengths available

Benefits

- Optimum adaptation to needs of an application
- Tailor-made solutions
- The best solution for each application
- Rough and rugged application suitable (heavy duty rod and belt materials available)
- High lateral stiffness design

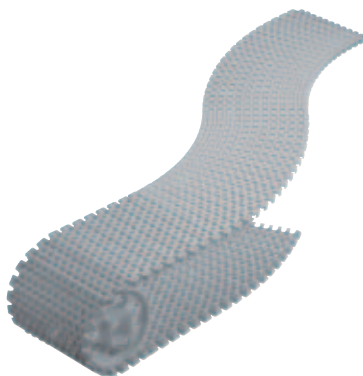

- Radius and straight transport with one single belt

- Larger runs without transfers
- Smaller number of drives and motors
- Reduced cost for entire system

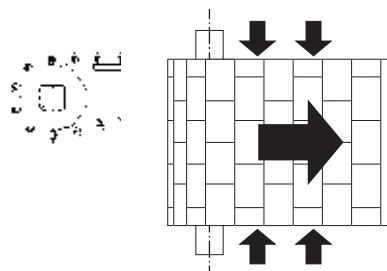

- Positive drive and tracking by belt engaged with sprocket
- Guided belt alignment

- Straight running, even under influence of transversal forces
- Exact positioning of goods
- No need for tensioning devices
- No re-adjustments, no downtimes
- Reliable tracking
- Elimination of belt edge damages
- Simple system design

Features and benefits

Plastic modular belts (contd.)

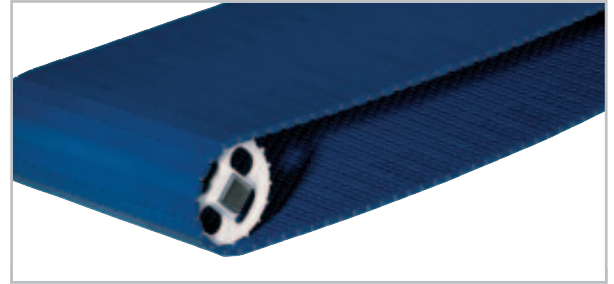

	Features	Benefits
	<ul style="list-style-type: none"> • Low temperature resistant material available (PE) 	<ul style="list-style-type: none"> → Suitable for cold store applications up to -70°C / -94°F → Multipurpose use
	<ul style="list-style-type: none"> • High temperature resistant material available (ST) 	<ul style="list-style-type: none"> → Suitable for warm/hot conditions without changing its features up to 240°C / 464°F → Ideal for shrink to wrap applications
	<ul style="list-style-type: none"> • Permanently antistatic belt material (+AS) and electrically conductive material (+EC) available 	<ul style="list-style-type: none"> → No interference with electronic devices → Less dust and dirt attraction → Process reliability → Low maintenance cost
	<ul style="list-style-type: none"> • Easy installation • Simple and fast assembling 	<ul style="list-style-type: none"> → Snap-in assembling method → Replacement of single belt modules → Easy repair
	<ul style="list-style-type: none"> • Nosebar construction suitable 	<ul style="list-style-type: none"> → Smooth transfer of small goods → Products remain perfectly oriented
	<ul style="list-style-type: none"> • Flame retardant modular belts (+FR) available (ISO 340, DIN 22103, DIN 4102, UL 94) 	<ul style="list-style-type: none"> → No spreading of fire to other buildings → Increased safety for people, buildings and installations

Rubber coated belts

Round belts

Polyurethane round belts (TPU)

Habasit (Polycord® and Habicord) round belts can be used as conveying elements or for driving applications. They are particularly suitable for angular gears. Habasit offers a comprehensive range of round belts made of high quality polyurethane in diameters between 2 and 15 mm. The round belts can be made endless on the machine by welding the ends which allows easy installation and maintenance with minimum downtimes.

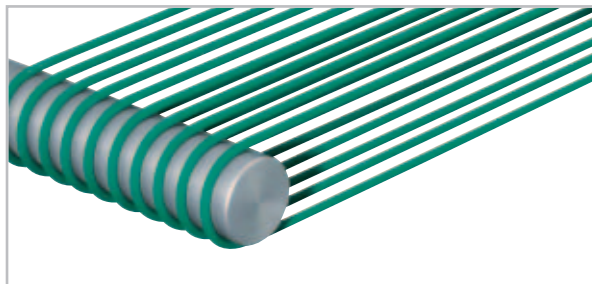

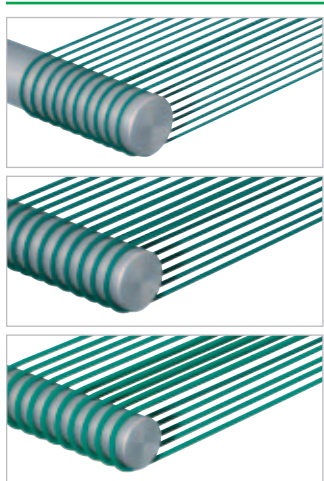
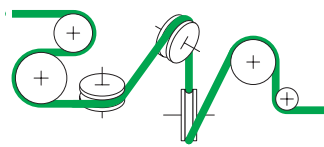
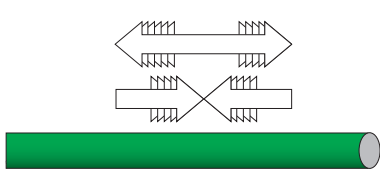
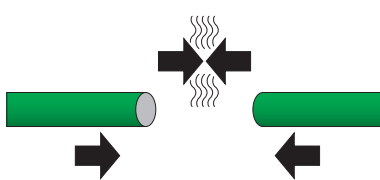
	Features	Benefits
 	<ul style="list-style-type: none"> • Multifunctional • Multidirectional 	<ul style="list-style-type: none"> → Simple and cost-effective machine design → Angular gear suitable
	<ul style="list-style-type: none"> • Elastic material (Polyurethane) 	<ul style="list-style-type: none"> → Forgiving/reducing shocks and able to cope with intermittent overloads → No tensioning device needed → No re-tensioning required → Simple and cost-effective machine design
	<ul style="list-style-type: none"> • Simple and quick joining (Quickmelt - butt joint) 	<ul style="list-style-type: none"> → Easy to handle welding method → High strength over joining area → Fast belt exchange possible → Maintenance-friendly product → Long belt life

Features and benefits

Polyester and Aramid power transmission belts

Power transmission belts / live roller drive belts (Polyester and Aramid reinforced)

Habasit power transmission belts are especially suitable for live roller conveyor applications (continuous / zero pressure systems). Wide range of power transmission capability and belt strengths are available. All belts can be joined with an easy to use, reliable joining system.

- **Polyester reinforced belts** (Polyester traction layer)
- **Aramid reinforced belts** (Aramid traction layer)



	Features	Benefits
	<ul style="list-style-type: none"> • High admissible work load • High longitudinal flexibility 	<ul style="list-style-type: none"> → Small pulley diameters suitable, compact design → Low energy consumption → Forgiving in case of shock loads (stop and go operation) → Reduced maintenance → Long service life
	<ul style="list-style-type: none"> • High friction NBR rubber surface 	<ul style="list-style-type: none"> → Constant power input over entire belt life → Reduced belt wear → Positive flow response → High output/throughput → Long service life
	<ul style="list-style-type: none"> • Stable modulus of elasticity 	<ul style="list-style-type: none"> → High dimensional stability → No re-tensioning → No downtimes
	<ul style="list-style-type: none"> • Low sensitivity to humidity 	<ul style="list-style-type: none"> → High dimensional stability → No re-tensioning → No downtimes
	<ul style="list-style-type: none"> • Low energy consumption 	<ul style="list-style-type: none"> → Lower energy cost
	<ul style="list-style-type: none"> • Permanently antistatic 	<ul style="list-style-type: none"> → Less dust and dirt attraction → Process reliability → Low maintenance cost
	<ul style="list-style-type: none"> • Simple and quick joining system (Flexproof) 	<ul style="list-style-type: none"> → Easy handling → Adhesive-free joint → Minimum equipment needed → Short machine downtimes



Call Toll Free: 1-866-711-4673
International: + 1-727-342-5086



Offering a comprehensive range of services is part of Habasit's belting solutions approach. We are committed partners of our customers, and we consider the sharing of knowledge and providing of support as an essential task. And this we offer:



Consulting and technical support

Habasit offers the best consulting and technical support on the belting market for fabric based belts and plastic modular belts founded on the experience and competence acquired in more than 50 years.



Belt selection and calculation

For our customers we select and calculate the most suitable belt for a specific application. However, customers may do it themselves thanks to the state-of-the-art Habasit selection and calculation programs "SeleCalc". For ordering these programs free of charge simply call the nearest Habasit partner or contact: info@habasit.com

CONVEY-SeleCalc = Fabric conveyor belt selection and calculation

LINK-SeleCalc = Plastic modular belt selection and calculation



Fabrication or assembling

We join fabric belts or assemble plastic modular belts at our locations or on-site directly on the machine or on the system.



Shortest lead times and installing service at hand

Habasit owns 25 Affiliated Companies located in North America, Europe and Asia, each with own inventory, fabrication, assembling and service facilities.

Together with our country managers, representative offices and a large number of qualified distributors we are in a position to react quickly, competently and reliably to customers' demands on an international scale.

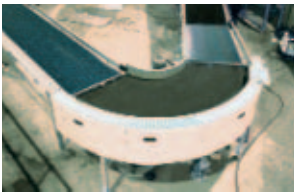

Testing at customer's site

We are testing process functionality, alternative products and variations of fabric belts or modular belts at the customer's site.



Legal and conformity check

We are supporting our customers with respect to declaration issues, conformity issues or conformance with national laws/authorities like Safety data sheets, Flame-retardant conformity, etc.



Belt inspection and analyses

We are carrying through belt inspections, analyses, surveys per location and work out the necessary reports.



Belt repair

We have developed sophisticated repair methods and equipments with proven effectiveness.

Process optimization proposals

We analyze processes together with the customer and submit proposals for optimization, e.g. added value for the machinery/process output, output increase.

Special belt fabrication

We offer special fabrications, such as longitudinal joining, edge sealing, profile welding, guide profiles welding, hole punching, side skirt installations, curve conveyor layout/cutting preparation, etc.

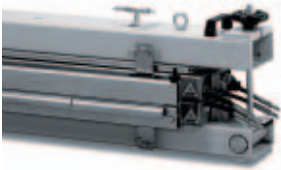

Joining tools and auxiliaries equipment

To support an effective and efficient fabrication of our belts, we develop and offer a broad range of tools and devices designed to meet the needs of our customers and distribution/service partners. This range covers the requirements of inhouse fabrication (series and specialties) as well as those of on-site installations of conveyor, power transmission belts and tapes such as slitters, skiving tools, finger cutting tools, hot-presses and auxiliaries like coiling and welding devices.

For plastic modular belts HabasitLINK® we are well equipped with own designed and manufactured semi-automated assembling machines.



Training

Habasit organizes training programs and provides supporting tools to ensure optimal use of our products and prolonging their life cycle. Fabrication, installing, assembling, maintenance and belt repair training is carried through at Habasit's or at customer's site.



Specific application knowledge transfer

Habasit provides application specific knowledge transfer for process specific issues to allow for optimal use of our products and to optimize machinery and processes.



Guaranteed performance

Our faith in our products is such that if one of our sales specialists has recommended a belt for a specific application, we will guarantee its performance. Should for any reason that belt not perform optimally, your money will be refunded unconditionally.

Customized Services



Designing the future "Partner in Design"

Habasit believes in partnership. For joint design developments our engineering team is looking for strong cooperation with the customer's engineering team, preferably at a very early stage. We offer this cooperation to large customers.

Co-design: We work together for success.



Testing offer for customer

R&D expertise, laboratory and test equipment are offered for the customer's specific process needs like mechanical endurance testing, influence of customer/process used chemicals/ingredients or thermal influence behavior on belts.

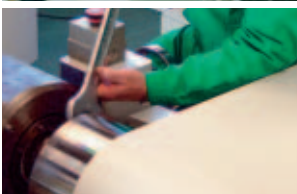

Belt monitoring

A customized Habasit service that includes maintenance, regular belt monitoring reports, regular review meetings with the responsible for process/production at customer's site.

Customized service agreements

According to the specific needs of our customers we offer customized services like inventory, emergency service, belt exchange services or order/re-order management.

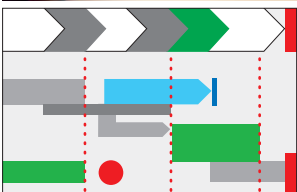

Project management

We are experienced partners for belting project co-ordination on an international scale for globally operating customers.

Comments/sketches

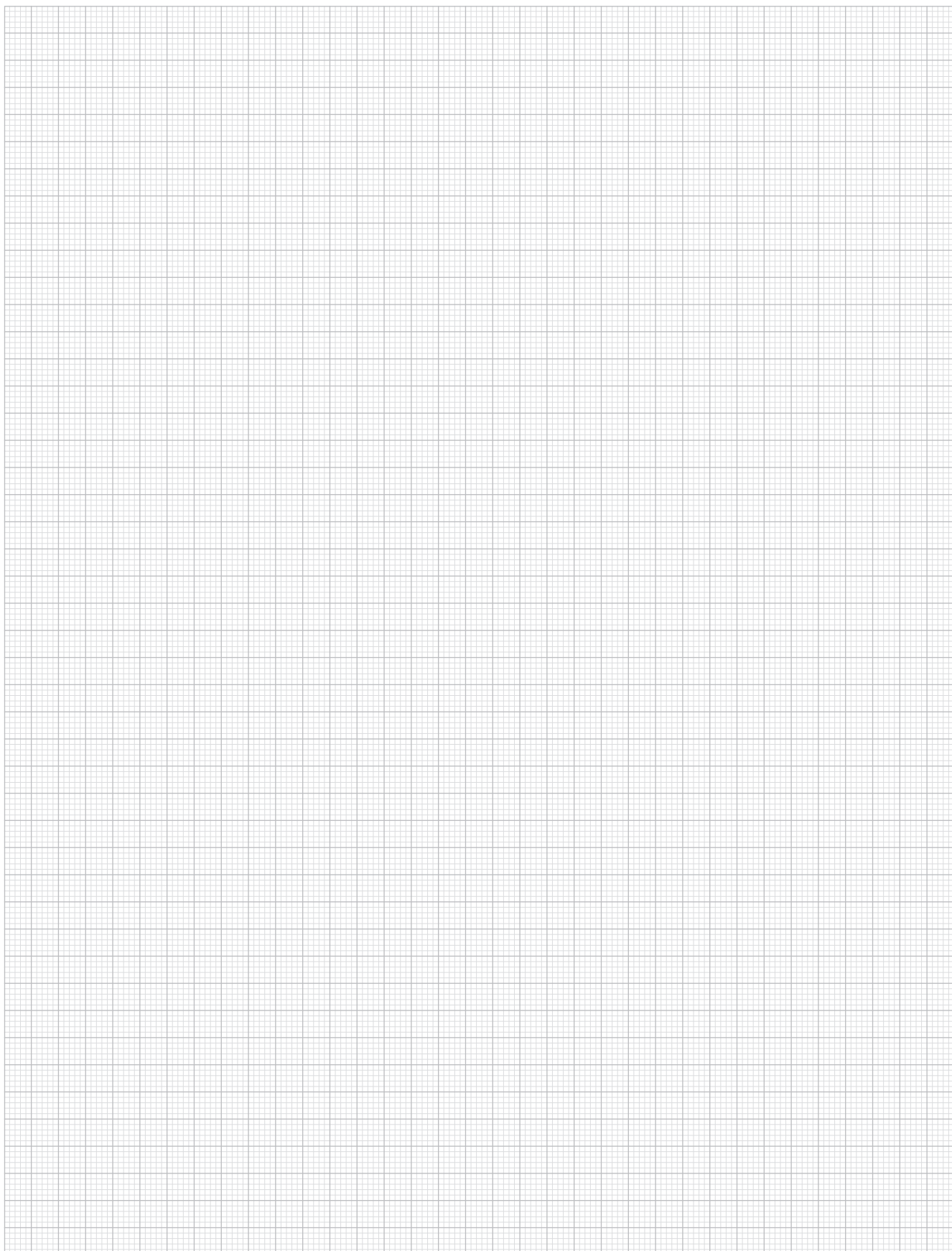

The Habasit Solution

**At Habasit, we listen. We innovate.
And we deliver integrated belting
solutions – right first time.**

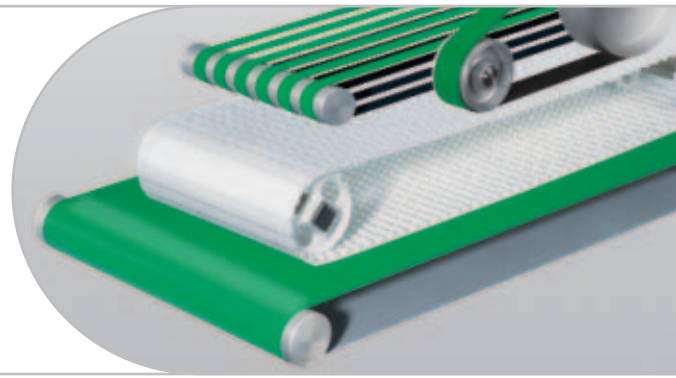

Customer first

Habasit understands that our success depends on the success of our customers. That's why we offer solutions, not just products; partnership, not just sales. Our innovative belting solutions are tailored exactly to specific needs. We guarantee best value for money in every application. Since its foundation in 1946, Habasit has proven this understanding of customer needs for more than 50 years. That's why we are the no. 1 in belting. Worldwide.



Product range

Habasit offers the largest selection of fabric and plastic modular belts in the industry. Our answer to any request is nothing less than a specific, tailor-made solution.

- Fabric conveyor & processing belts
- Plastic modular belts
- Power transmission belts
- Machine tapes
- Seamless belts
- Round belts
- Timing belts
- Auxiliaries (e.g. profiles, tools)



Innovation / R&D

Habasit is strongly committed to the continuous development of innovative, value-added solutions. More than 3% of our staff is dedicated exclusively to R&D; the annual investment in this area exceeds 8% of the turnover.

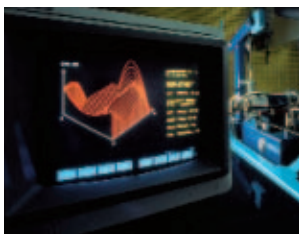

Global network

Facts & figures

Founded	1946
Turnover 2003	CHF 418 million
Sales to market	4.2 million m ²
Employees	more than 2200
Production plants	12
Affiliated companies	25
Representatives	in over 50 countries
Service centers	over 250 globally

Services & guarantees

Our extensive organization is prepared to support you anywhere in the world. Engineering and emergency assistance, quotes and order status are just a phone call away. Wherever you are. Whenever you need us.

Quality

Highest quality standards are found not only in products, but also in our employees' daily work process. Based on a worldwide TQM approach, Habasit started very early to implement a quality system and was certified already in 1987 according to ISO 9001 / EN 29001. In 1996 Habasit was certified according to ISO 9001:1994. Since then we undergo periodically quality audits performed by an independent certification body. In the year 2002 we achieved certification according to the revised standard ISO 9001:2000.



GOODYEAR
GOODYEARBELTING.COM

**Call Toll Free: 1-866-711-4673
International: + 1-727-342-5086**

**We Ship
World Wide**