

**OSHA 29 CFR Part 1910
Vented, Locking Handle, Female Pipe Ends, Panel Mount XVVP502P**

| PART NO. | PIPE THD. | B HEX | C HEX | F | G | K | H | L | M | N | D FLOW Ø |
|-------------|-----------|--------|--------|-----|------|------|------|------|------|------|----------|
| XVVP502P-4 | 1/4 | 15/16 | 15/16 | .50 | 1.12 | 1.11 | 3.96 | 4.90 | 2.03 | 2.47 | .375 |
| XVVP502P-6 | 3/8 | 15/16 | 15/16 | .50 | 1.12 | 1.11 | 3.96 | 4.90 | 2.03 | 2.47 | .375 |
| XVVP502P-8 | 1/2* | 1-1/16 | 1-1/16 | .50 | 1.12 | 1.23 | 3.96 | 5.00 | 2.20 | 2.58 | .500 |
| XVVP502P-12 | 3/4** | 1-1/4 | 1-5/16 | .87 | 1.37 | 1.45 | 3.96 | 5.25 | 2.42 | 2.81 | .685 |
| XVVP502P-16 | 1** | 1-1/2 | 1-9/16 | .87 | 1.37 | 1.58 | 3.96 | 5.34 | 2.75 | 3.08 | .875 |

For use with 5/16" Ø shank lock

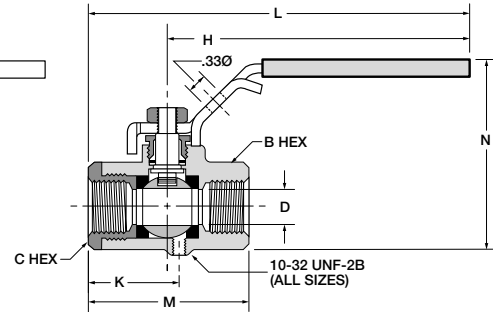
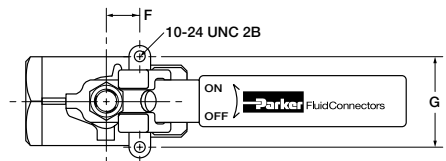
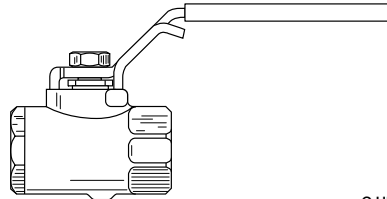

Tee Handle, Female Pipe Ends, Panel Mount XV502P-X-04

| PART NO. | PIPE THD. | B HEX | C HEX | F | G | H | L | M | N | D FLOW Ø |
|--------------|-----------|--------|--------|-----|------|------|------|------|------|----------|
| XV502P-4-04 | 1/4 | 15/16 | 15/16 | .50 | 1.12 | 1.25 | 2.50 | 2.03 | 1.87 | .375 |
| XV502P-6-04 | 3/8 | 15/16 | 15/16 | .50 | 1.12 | 1.25 | 2.50 | 2.03 | 1.87 | .375 |
| XV502P-8-04 | 1/2* | 1-1/16 | 1-1/16 | .50 | 1.12 | 1.25 | 2.50 | 2.20 | 1.98 | .500 |
| XV502P-12-04 | 3/4** | 1-1/4 | 1-5/16 | .87 | 1.37 | 1.25 | 2.50 | 2.42 | 2.20 | .685 |
| XV502P-16-04 | 1** | 1-1/2 | 1-9/16 | .87 | 1.37 | 1.25 | 2.50 | 2.75 | 2.48 | .875 |

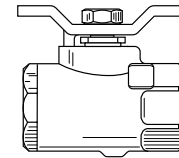
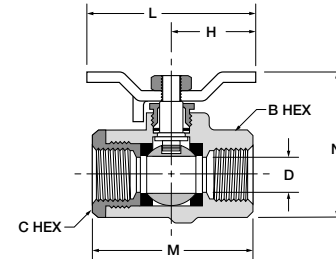
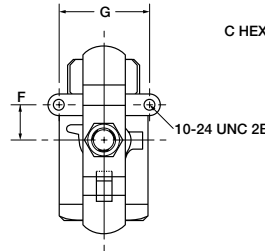

Oval Handle, Female Pipe Ends, Panel Mount XV502P-X-21

| PART NO. | PIPE THD. | B HEX | C HEX | F | G | H | L | M | N | D FLOW Ø |
|--------------|-----------|--------|--------|-----|------|------|------|------|------|----------|
| XV502P-4-21 | 1/4 | 15/16 | 15/16 | .50 | 1.12 | 1.74 | 3.49 | 2.03 | 2.38 | .375 |
| XV502P-6-21 | 3/8 | 15/16 | 15/16 | .50 | 1.12 | 1.74 | 3.49 | 2.03 | 2.38 | .375 |
| XV502P-8-21 | 1/2* | 1-1/16 | 1-1/16 | .50 | 1.12 | 1.74 | 3.49 | 2.20 | 2.49 | .500 |
| XV502P-12-21 | 3/4** | 1-1/4 | 1-5/16 | .87 | 1.37 | 1.74 | 3.48 | 2.42 | 2.71 | .685 |
| XV502P-16-21 | 1** | 1-1/2 | 1-9/16 | .87 | 1.37 | 1.74 | 3.48 | 2.75 | 2.99 | .875 |

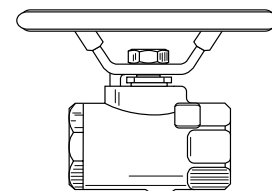
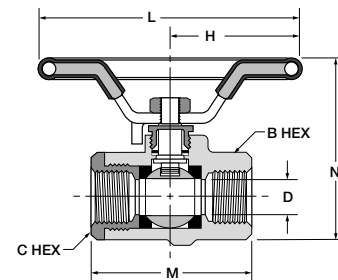
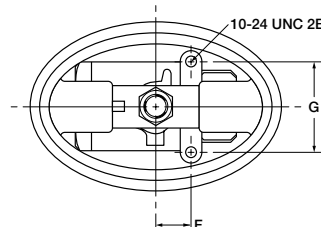

*PTF special short. **PTF special extra short

J